



# TOSHIBA

For an overview of steps for installing, setting up, and using your new TV, see page 8.

# OWNER'S MANUAL

## Integrated HD Projection Television

COLOR STREAM<sup>®</sup> HD

TouchFocus<sup>®</sup>

THEATER WIDE<sup>®</sup> HD

VIRTUAL  
DOLBY  
DIGITAL

SRS  
TruSurround 5.1  
DIGITAL

SRS  
WOW

TV  
GUIDE

HDMI



# 51HX94 57HX94

### Owner's Record

The model number and serial number are on the back of your TV. Record these numbers in the spaces below. Refer to these numbers whenever you communicate with your Toshiba dealer about this TV.

Model number:

Serial number:

© 2004 TOSHIBA CORPORATION  
All Rights Reserved

23566398



## Dear Customer,

Thank you for purchasing this Toshiba TV. This manual will help you use the many exciting features of your new TV.

**Before operating the TV, please read this manual completely**, and keep it nearby for future reference.

### Safety Precautions

**WARNING: TO REDUCE THE RISK OF FIRE OR ELECTRIC SHOCK, DO NOT EXPOSE THIS APPLIANCE TO RAIN OR MOISTURE.**



**WARNING**  
**RISK OF ELECTRIC SHOCK!**  
**DO NOT OPEN.**



**WARNING: TO REDUCE THE RISK OF ELECTRIC SHOCK, DO NOT REMOVE COVER (OR BACK).**  
**NO USER-SERVICEABLE PARTS INSIDE. REFER SERVICING TO QUALIFIED SERVICE PERSONNEL.**



The lightning flash with arrowhead symbol, within an equilateral triangle, is intended to alert the user to the presence of uninsulated "dangerous voltage" within the product's enclosure that may be of sufficient magnitude to constitute a risk of electric shock to persons.



The exclamation point within an equilateral triangle, is intended to alert the user to the presence of important operating and maintenance (servicing) instructions in the literature accompanying the appliance.



### CAUTION: HOT SURFACE!

**THE CableCARD™ CAN REACH A HIGH TEMPERATURE IF THE COOLING FAN STOPS.**



If the cooling fan stops, turn OFF the TV, unplug the TV power cord, and wait at least 30 minutes before removing the CableCARD.

### NOTE TO CATV INSTALLERS

This is a reminder to call the CATV system installer's attention to Article 820-40 of the NEC, which provides guidelines for proper grounding and, in particular, specifies that the cable ground shall be connected to the grounding system of the building, as close to the point of cable entry as practical. For additional antenna grounding information, see items 25 and 26 on page 4.

### NOTICE OF POSSIBLE ADVERSE EFFECTS ON TV PICTURE TUBE

If a fixed (non-moving) pattern remains on the TV screen for long periods of time, the image can become permanently engrained in the picture tube. **This type of damage is NOT COVERED BY YOUR WARRANTY.** See item 33 on page 4.



### NOTE: NEVER CONNECT THIS TV TO A PERSONAL COMPUTER (PC).

THIS TV IS NOT INTENDED FOR USE WITH A PC.

## Child Safety

### It Makes A Difference Where Your TV Stands



**Congratulations on your purchase! As you enjoy your new TV, keep these safety tips in mind:**

### The Issue

- If you are like most consumers, you have a TV in your home. Many homes, in fact, have more than one TV.
- The home theater entertainment experience is a growing trend, and larger TVs are popular purchases; however, they are not always supported on the proper TV stands.
- Sometimes TVs are improperly secured or inappropriately situated on dressers, bookcases, shelves, desks, audio speakers, chests, or carts. As a result, TVs may fall over, causing unnecessary injury.

### We Care!

- The consumer electronics industry is committed to making home entertainment enjoyable and safe.
- The Consumer Electronics Association formed the Home Entertainment Support Safety Committee, comprised of TV and consumer electronics furniture manufacturers, to advocate children's safety and educate consumers and their families about television safety.

### Tune Into Safety

- One size does NOT fit all! Use appropriate furniture large enough to support the weight of your TV (and other electronic components).
- Use appropriate angle braces, straps, and anchors to secure your furniture to the wall (but never screw anything directly into the TV).
- Carefully read and understand the other enclosed instructions for proper use of this product.
- Do not allow children to climb on or play with furniture and TVs.
- Avoid placing any item on top of your TV (such as a VCR, remote control, or toy) that a curious child may reach for.
- Remember that children can become excited while watching a program and can potentially push or pull a TV over.
- Share our safety message about this hidden hazard of the home with your family and friends. Thank you!



2500 Wilson Blvd.  
Arlington, VA 22201 U.S.A.  
Tel. 703-907-7600 Fax 703-907-7690  
www.CE.org

CEA is the Sponsor, Producer and Manager of the International CES®

## Important Safety Instructions

- 1) **Read these instructions.**
- 2) **Keep these instructions.**
- 3) **Heed all warnings.**
- 4) **Follow all instructions.**



- 5) **Do not use this apparatus near water.**

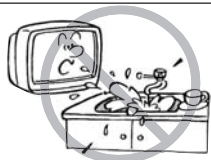

- 6) **Clean only with a dry cloth.**

- 7) **Do not block any ventilation openings.** Install in accordance with the manufacturer's instructions.



- 8) **Do not install near any heat sources** such as radiators, heat registers, stoves, or other apparatus (including amplifiers) that produce heat.

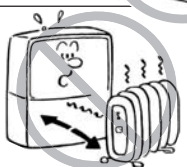

- 9) **Do not defeat the safety purpose of the polarized or grounding type plug.** A polarized plug has two blades with one wider than the other. A grounding type plug has two blades and a third grounding prong. The wide blade or the third prong are provided for your safety. If the provided plug does not fit into your outlet, consult an electrician for replacement of the obsolete outlet.

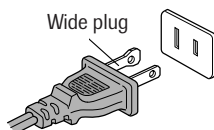

- 10) **Protect the power cord** from being walked on or pinched, particularly at plugs, convenience receptacles, and the point where it exits the apparatus.

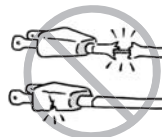

- 11) **Only use attachments/accessories specified by the manufacturer.**

- 12) **Use only with the cart, stand, tripod, bracket, or table specified by the manufacturer, or sold with the apparatus.** When a cart is used, use caution when moving the cart/apparatus combination to avoid injury from tip-over.



- 13) **Unplug this apparatus during lightning storms or when unused for long periods of time.**



- 14) **Refer all servicing to qualified service personnel.**

Service is required when the apparatus has been damaged in any way, such as power supply cord or plug is damaged, liquid has been spilled or objects have fallen into the apparatus, the apparatus has been exposed to rain or moisture, does not operate normally, or has been dropped.



- 15) **CAUTION:** To reduce the risk of electric shock, do not use the polarized plug with an extension cord, receptacle, or other outlet unless the blades can be inserted completely to prevent blade exposure.

## Installation, Care, and Service

### Installation

Follow these recommendations and precautions and heed all warnings when installing your TV:

- 16) Never modify this equipment. Changes or modifications may void: a) the warranty, and b) the user's authority to operate this equipment under the rules of the Federal Communications Commission.

- 17) **DANGER: RISK OF SERIOUS PERSONAL INJURY, DEATH, OR EQUIPMENT DAMAGE!** Never place the TV on an unstable cart, stand, or table. The TV may fall, causing serious personal injury, death, or serious damage to the TV.



- 18) Never place or store the TV in direct sunlight; hot, humid areas; areas subject to excessive dust or vibration; or locations with temperatures at or below 41°F (5°C).

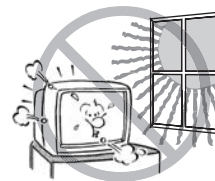

- 19) Always place the TV on the floor or a sturdy, level, stable surface that can support the weight of the unit.



- 20) Never place items such as vases, aquariums, or candles on top of the TV.



- 21) Never block or cover the slots or openings in the TV cabinet back, bottom, and sides. Never place the TV:

- on a bed, sofa, rug, or similar surface;
- too close to drapes, curtains, or walls; or
- in a confined space such as a bookcase, built-in cabinet, or any other place with poor ventilation.



The slots and openings are provided to protect the TV from overheating and to help maintain reliable operation of the TV.

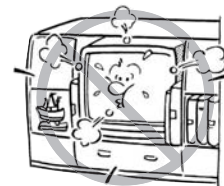

- 22) Never allow anything to rest on or roll over the power cord, and never place the TV where the power cord is subject to wear or abuse.

- 23) Never overload wall outlets and extension cords.

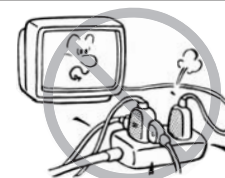



- 24) Always operate this equipment from a 120 VAC, 60 Hz power source only.



- 25) Always make sure the antenna system is properly grounded to provide adequate protection against voltage surges and built-up static charges (see Section 810 of the National Electric Code).

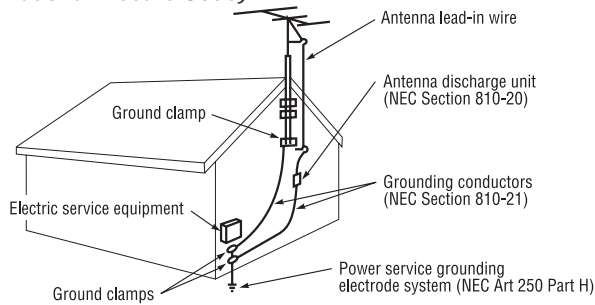

- 26) **! DANGER: RISK OF SERIOUS PERSONAL INJURY OR DEATH!**

- Use extreme care to make sure you are never in a position where your body (or any item you are in contact with, such as a ladder or screwdriver) can accidentally touch overhead power lines. Never locate the antenna near overhead power lines or other electrical circuits.
- Never attempt to install any of the following during lightning activity:
  - a) an antenna system; or b) cables, wires, or any home theater component connected to an antenna or phone system.

## Care

For better performance and safer operation of your TOSHIBA TV, follow these recommendations and precautions:

- 27) Always sit approximately 10–25 feet away from the TV and as directly in front of it as possible. The picture can appear dull if you sit too far to the left or right of the TV, or if sunlight or room lights reflect on the screen. Turn the TV off to check for reflections on the screen, and then remove the source of reflections while viewing the TV.

- 28) Always unplug the TV before cleaning. Never use liquid or aerosol cleaners. Always clean the screen and cabinet with dry cloth only. Clean the cabinet back so dust does not clog the slots or fan. Never spray volatile compounds (such as insecticide) on the cabinet, which may cause cabinet discoloration or damage.



- 29) **! WARNING: RISK OF ELECTRIC SHOCK!** Never spill liquids or push objects of any kind into the TV cabinet slots.

- 30) If the air temperature rises suddenly (for example, when the TV is first delivered), condensation may form on the lenses. This can make the picture appear distorted or the color appear faded. If this happens, turn off the TV for 6 to 7 hours to allow the condensation to evaporate.

- 31) For added protection of your TV from lightning and power surges, always unplug the power cord and disconnect the antenna from the TV if you leave the TV unattended or unused for long periods of time.

- 32) During normal use, the TV may make occasional snapping or popping sounds. This is normal, especially when the unit is being turned on or off. If these sounds become frequent or continuous, unplug the power cord and contact a Toshiba Authorized Service Center.



- 33) **Possible Adverse Effects on TV Picture Tube:** If a fixed (non-moving) pattern remains on the TV screen for long periods of time, the image can become permanently engrained in the picture tube and cause subtle but permanent ghost images. **This type of damage is NOT COVERED BY YOUR WARRANTY.** Never leave your TV on for long periods of time while it is displaying the following formats or images:

- **Fixed Images**, such as PIP/POP windows, stock tickers, video game patterns, TV station logos, closed captions, and websites.
- **Special Formats** that do not use the entire screen. For example, viewing letterbox style (16:9) media on a normal (4:3) display (gray bars at top and bottom of screen); or viewing normal style (4:3) media on a widescreen (16:9) display (gray bars on left and right sides of screen).

## Service

- 34) **! WARNING: RISK OF ELECTRIC SHOCK!** Never attempt to service the TV yourself. Opening and removing the covers may expose you to dangerous voltage or other hazards. Refer all servicing to a Toshiba Authorized Service Center.

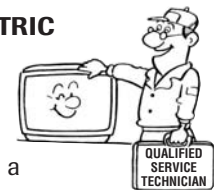

- 35) If you have the TV serviced:
- Ask the service technician to use only replacement parts specified by the manufacturer.
  - Remove the CableCARD™ and/or memory card (if applicable) before servicing.
  - Upon completion of service, ask the service technician to perform routine safety checks to determine that the TV is in safe operating condition.

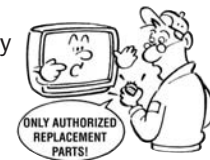

**Note:** Toshiba is not responsible for loss of data as a result of servicing. After the TV is serviced, you may need to repeat the setup process for applicable features.

- 36) When the TV reaches the end of its useful life, ask a qualified service technician to properly dispose of the TV. Improper disposal may result in a picture tube implosion and possible personal injury.





## Important Safety Precautions for Split Cabinet Feature (Model 57HX94 only)

Toshiba TV model 57HX94 has a split cabinet feature that allows disassembly of the cabinet into two sections during installation.

For details, please refer to the insert titled "Disassembly/ Reassembly Instructions for Split Cabinet Feature" that accompanied this owner's manual in the accessory pack. If you do not have the insert, you can download a copy of it from our Web site ([www.toshiba.com/tacp](http://www.toshiba.com/tacp) in the U.S.A.). If you do not have access to the Internet, call 1-800-631-3811 to have a copy of the insert mailed to you.



**WARNING: If you split the cabinet for any purpose, NEVER energize the bottom section until it is completely and properly installed. Energizing the disassembled bottom section and subjecting it to intentional misuse (for example, exposing it to a foreign object) creates the potential for an electrical shock hazard that could result in death or serious injury.**

**CAUTION:** If you use the split cabinet feature, ALWAYS handle and treat the top section of the TV cabinet, which contains a glass mirror, with great care. If subjected to excessive mechanical abuse (for example, if bumped or dropped), the mirror may break, creating exposed glass fragments with sharp edges. Contact with these glass fragments may result in injury.

### Installation, Care, and Service

**CAUTION:** The split cabinet feature allows disassembly of the cabinet into two sections during installation. If you use the split cabinet feature, follow these precautions while the two sections of the TV cabinet are disassembled:

- 1) Always handle and treat the top section of the TV cabinet (with the viewing screen), which contains a glass mirror, with great

care. If subjected to excessive mechanical abuse (for example, if bumped or dropped), the mirror may break, creating exposed glass fragments with sharp edges. Contact with these glass fragments may result in injury.

- 2) Never temporarily locate the disassembled bottom section in an area where it may be exposed to foreign objects or abuse (for example, areas where children may be playing, where items may fall on top of the unit, or where liquids may spill into the unit). Failure to follow this instruction may result in damage to the optic components of the TV. SUCH DAMAGE IS NOT COVERED UNDER THE TOSHIBA LIMITED WARRANTY.
- 3) Always keep the top and bottom sections of the TV cabinet in an upright position while disassembled. Failure to follow this instruction may result in damage to the TV, including but not limited to the optic components, cabinet, bezel, and glass mirror. SUCH DAMAGE IS NOT COVERED UNDER THE TOSHIBA LIMITED WARRANTY.

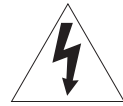

- 4) **WARNING: Never energize the bottom section of the TV cabinet while disassembled. Failure to follow this instruction could result in death or serious injury.**

- 5) Never place anything on top of the bottom section of the TV cabinet. Failure to follow this instruction may result in damage to the optic components. SUCH DAMAGE IS NOT COVERED UNDER THE TOSHIBA LIMITED WARRANTY.
- 6) Never store or transport the unit while it is disassembled. Failure to follow this instruction may result in damage to the TV, including but not limited to the optic components, cabinet, bezel, and glass mirror. SUCH DAMAGE IS NOT COVERED UNDER THE TOSHIBA LIMITED WARRANTY.

## Contents

<b>Important Safety Information .....</b>	<b>2-5</b>
<b>Chapter 1: Introduction .....</b>	<b>7</b>
Welcome to Toshiba .....	7
Features of your new TV .....	7
<b>Overview of steps for installing, setting up, and using your new TV .....</b>	<b>8</b>
<b>Chapter 2: Connecting your TV .....</b>	<b>9</b>
TV front panel controls and connections .....	9
TV back panel connections .....	10
Overview of cable types .....	11
About the connection illustrations .....	12
Connecting a digital CableCARD™ .....	12
Connecting a VCR and antenna or Cable TV (no Cable box) .....	13
Connecting a camcorder .....	13
Connecting a VCR and Cable box .....	14
Connecting a VCR and satellite receiver .....	15
Connecting a DVD player with S-video, a VCR, and a Cable box .....	16
Connecting a DVD player with ColorStream® (component video) and a VCR .....	17
Connecting two VCRs .....	18

Connecting an HDMI™ or a DVI device to the HDMI input .....	19
Connecting a digital audio system .....	20
Connecting an analog audio system .....	20
Controlling infrared remote-controlled devices through the TV (IR pass-through) .....	21
Connecting IEEE-1394 video devices .....	22
G-LINK™ connection .....	25
<b>Chapter 3: Using the remote control .....</b>	<b>26</b>
Learning about the remote control .....	26
Installing the remote control batteries .....	27
Using the remote control MODE button to control your other devices .....	27
Remote Control functional key chart .....	28
Programming the remote control to operate your other devices .....	30
Multi-brand remote control device codes .....	32
<b>Chapter 4: Menu layout and navigation .....</b>	<b>34</b>
Main menu layout .....	34
Setup/Installation menu layout .....	35
Navigating the menu system .....	35

*(Continued on next page)*

# Contents *(Continued from previous page)*

<b>Chapter 5: TV Guide On Screen™ system setup</b> .....	<b>36</b>	Scrolling the TheaterWide® picture .....	72
<b>Chapter 6: Setting up your TV</b> .....	<b>40</b>	Using the auto aspect ratio feature .....	72
Selecting the menu language .....	40	Selecting the cinema mode (480i signals only) .....	73
Configuring the antenna input sources .....	40	Selecting the display format (480i and 480p signals only) ...	73
Programming channels into the TV's channel memory .....	41	Using the POP features .....	74
Programming channels automatically .....	41	Using the POP double-window feature .....	74
Manually adding and deleting channels in the		Switching the speaker audio (main or POP) .....	75
channel memory .....	42	Freezing the main picture in the	
Programming your favorite channels .....	43	POP double-window .....	75
Setting up and using TheaterNet™ on-screen		POP double-window aspect ratio .....	76
device control .....	44	Using the favorite channel scan feature .....	76
Setting up TheaterNet .....	44	Adjusting the picture .....	77
Using the TheaterNet control icons .....	45	Selecting the picture mode .....	77
TheaterNet IR device codes .....	46	Adjusting the picture quality .....	77
Adjusting the color convergence .....	49	Resetting the picture settings .....	77
Setting the AVHD device skip time .....	50	Using the Night Mode feature .....	78
Setting the HDMI™ audio mode .....	50	Using CableClear™ DNR (digital noise reduction) .....	78
Setting the time and date .....	51	Adjusting the velocity scan modulation .....	79
Viewing the CableCARD™ menu .....	51	Selecting the color temperature .....	79
Viewing the digital signal meter .....	52	Resetting the advanced picture settings .....	79
Viewing the system status .....	52	Using the closed caption mode .....	80
<b>Chapter 7: Using the TV Guide On Screen™</b>		Advanced closed captions .....	80
<b>interactive program guide</b> .....	<b>53</b>	Digital closed captions .....	80
Setting up the TV Guide On Screen system .....	53	Adjusting the audio .....	81
Navigating the TV Guide On Screen system .....	54	Muting the sound .....	81
TV Guide On Screen remote control functions .....	54	Digital audio selector .....	81
Video Window .....	55	Selecting stereo/SAP broadcasts .....	81
Panel Menus .....	55	Adjusting the audio quality .....	82
Info Box .....	56	Using the StableSound™ feature .....	82
TV Guide On Screen Icons .....	56	Resetting your audio adjustments .....	82
TV Guide On Screen Services .....	57	Using the Dolby® Virtual with SRS TruSurround sound	
LISTINGS screen .....	57	feature .....	82
SEARCH screen .....	58	Turning off the built-in speakers .....	82
RECORDINGS screen .....	60	Using the SRS WOW™ surround sound feature .....	83
SCHEDULE screen .....	61	Selecting the optical audio output format .....	83
Record features .....	61	Using the memory card picture viewer .....	84
Remind features .....	63	Memory card specifications .....	84
SETUP screen .....	65	Viewing digital photos on your TV .....	85
Change system settings .....	65	Memory card care and handling .....	86
Change channel display .....	65	Setting the ON/OFF timer .....	86
Change default options .....	66	Setting the sleep timer .....	87
<b>Chapter 8: Using the TV's features</b> .....	<b>67</b>	Displaying TV setting information on-screen .....	87
Selecting the video input source to view .....	67	Understanding the auto power off feature .....	87
Labeling the video input sources .....	68	Understanding the last mode memory feature .....	87
Tuning channels .....	69	<b>Chapter 9: Using the Locks menu</b> .....	<b>88</b>
Tuning to the next programmed channel .....	69	Entering the PIN code .....	88
Using SpeedSurf to change to a specific		If you cannot remember your PIN code .....	88
programmed channel .....	69	Changing your PIN code .....	88
Tuning to a specific channel (programmed or		Blocking TV programs and movies by rating (V-Chip) .....	89
unprogrammed) .....	69	Blocking channels .....	90
Switching between two channels using		Unlocking programs temporarily .....	90
Channel Return .....	69	Locking video inputs .....	90
Switching between two channels using		Using the GameTimer™ .....	91
SurfLock™ .....	69	Using the front panel lock feature .....	91
Selecting the picture size .....	70	<b>Chapter 10: Troubleshooting</b> .....	<b>92</b>
Natural picture size .....	70	General troubleshooting .....	92
TheaterWide® 1 picture size .....	71	LED indications .....	94
TheaterWide® 2 picture size .....	71	TV Guide On Screen FAQs .....	94
TheaterWide® 3 picture size .....	71	<b>Chapter 11: Appendix</b> .....	<b>98</b>
Full picture size .....	71	Specifications .....	98
		Limited United States Warranty .....	99
		Limited Canada Warranty .....	100
		<b>Index</b> .....	<b>102</b>

# 1 Introduction

## Welcome to Toshiba

Thank you for purchasing this Toshiba TV, one of the most innovative projection TVs on the market. The goal of this manual is to guide you through setting up and operating your TV as quickly as possible.

- This manual applies to models 51H94 and 57H94. Before you start reading, check the model number on the back of your TV.
- Instructions in this manual are based on using the remote control. You also can use the controls on the TV front panel if they have the same name as those referred to on the remote control.
- The front panel (behind the door) and back panel provide terminals for connecting other equipment to your TV. See page 9 for front panel details. See page 10 for back panel details. See pages 12–25 for instructions on connecting other devices to your TV.
- Model 57H94 is used in this manual for illustration purposes.
- **Please read all safety and operating instructions in this manual carefully, and keep this manual for future reference.**

## Features of your new TV

The following are just a few of the many exciting features of your new Toshiba integrated HD, widescreen, projection TV:

- **Integrated digital tuning (8VSB ATSC and QAM)** eliminates the need for a separate digital converter set-top box (in most cases).
- **TV Guide On Screen®** no-fee interactive program guide (Chapters 5 and 7).
- **Digital CableCARD™** module slot for viewing encrypted digital Cable TV programs (page 12).
- **Digital recording** by connecting a D-VHS digital recording device or a **Toshiba Symbio™ 160HD4 A/V Hard Drive** to one of the IEEE-1394 jacks. You can record high definition and standard definition material from either tuner (page 23).
- **Memory card slots** [SD (Secure Digital™), SmartMedia™, MMC, Memory Stick™ (Pro), CompactFlash®] for viewing JPEG files as a “slide show” (page 84).
- **TheaterNet™** icons for on-screen control of external **IR** and **IEEE-1394** devices (page 44).
- **Two IEEE-1394 ports** for multi-device connection and control (page 22).
- **Two HDMI/DVI** digital, high-definition multimedia interface inputs (page 19).
- **Two sets of ColorStream® HD** high-resolution component video inputs (pages 15 and 17).
- **Dolby® Digital\*** (page 20 and 83) Virtual Dolby Digital with SRS TruSurround (page 83), and **SRS® WOW** (page 83) audio technologies.
- **Digital Audio Out** optical audio connection (page 20).
- **TouchFocus®** automatic color convergence (page 49).
- **CrystalScan HDSC** (all-time 1080i scan) with user-selectable 540p.
- **CableClear™ DNR** digital picture noise reduction (page 78).
- Double-window **POP** (page 74) and multi-window **Favorites** (page 76) features.

### NOTE: AFTER SETUP, PRESS THE TouchFocus® BUTTON.

Convergence may drift as a result of relocating or adjusting the position of the TV. The TV's TouchFocus® system automatically adjusts the color convergence. After setting up your TV, it is recommended that you set the convergence by pressing the TouchFocus button on the TV's front panel. For instructions on manually adjusting the color convergence, see page 49.

In the United States, TV GUIDE and other related marks are registered marks of Gemstar-TV Guide International, Inc. and/or one of its affiliates. In Canada, TV GUIDE is a registered mark of Transcontinental Inc., and is used under license by Gemstar-TV Guide International, Inc. The TV Guide On Screen system is manufactured under license from Gemstar-TV Guide International, Inc. and/or one of its affiliates. The TV Guide On Screen system is protected by one or more of the following issued United States patents: 6,498,895, 6,418,556, 6,331,877, 6,239,794, 6,154,203, 5,940,073, 4,908,713, 4,751,578, 4,706,121.

**GEMSTAR-TV GUIDE INTERNATIONAL, INC. AND/OR ITS RELATED AFFILIATES AND/OR TOSHIBA AMERICA CONSUMER PRODUCTS, L.L.C. ARE NOT IN ANY WAY LIABLE FOR THE ACCURACY OF THE PROGRAM SCHEDULE INFORMATION PROVIDED BY THE TV GUIDE ON SCREEN SYSTEM. IN NO EVENT SHALL GEMSTAR-TV GUIDE INTERNATIONAL, INC. AND/OR ITS RELATED AFFILIATES AND/OR TOSHIBA AMERICA CONSUMER PRODUCTS, L.L.C. BE LIABLE FOR ANY AMOUNTS REPRESENTING LOSS OF PROFITS, LOSS OF BUSINESS, OR INDIRECT, SPECIAL, OR CONSEQUENTIAL DAMAGES IN CONNECTION WITH THE PROVISION OR USE OF ANY INFORMATION, EQUIPMENT, OR SERVICES RELATING TO THE TV GUIDE ON SCREEN SYSTEM.**

- A recording device is required for recording. Over-the-air or cable access to stations carrying TV Guide On Screen data is required for the TV Guide On Screen system to operate. TV Guide On Screen data is not provided by Toshiba America Consumer Products, L.L.C. The provider of the data may elect to discontinue the service or it may cease to be (or never be) available in your area. In any of these circumstances, the TV Guide On Screen feature will not function.
- This product incorporates copyright protection technology that is protected by U.S. patents and other intellectual property rights. Use of this copyright protection technology must be authorized by Macrovision and is intended for home and other limited pay-per-view uses only, unless otherwise authorized by Macrovision. Reverse engineering or disassembly is prohibited.
- SRS WOW, SRS and the (●) logo are trademarks of SRS Labs, Inc. SRS WOW technology is incorporated under license from SRS Labs, Inc.
- \*Manufactured under license from Dolby Laboratories. Dolby and the double-D logo are registered trademarks of Dolby Laboratories.
- CableCARD is a trademark of Cable Television Laboratories, Inc.
- SmartMedia is a registered trademark of Toshiba Corporation.
- SD (Secure Digital) memory card is a trademark of Matsushita Electric Industry, Toshiba Corporation, and SanDisk Corporation.
- MMC and MultiMediaCard are trademarks of Infineon Technologies AG and licensed to MMCA (MultiMediaCard Association).
- Memory Stick is a trademark of Sony Corporation.
- Toshiba is an authorized licensee of the CompactFlash® and CF logo® registered trademarks.

Copyright © 2004 TOSHIBA CORPORATION. All rights reserved.

## Overview of steps for installing, setting up, and using your new TV

Follow these steps to set up your TV and begin using its many exciting features.

1. **Carefully read the important safety, installation, care, and service information on pages 2–5. Keep this manual for future reference.**
2. **Observe the following when choosing a location for the TV:**
  - Place the TV on the floor only.
  - Place the TV in a location where light does not reflect on the screen.
  - Place the TV far enough from walls and other objects to allow proper ventilation. Inadequate ventilation may cause overheating, which will damage the TV. **THIS TYPE OF DAMAGE IS NOT COVERED UNDER THE TOSHIBA WARRANTY.**
  - Read "Installation" on pages 3–4.
3. **If you need to split your TV** into two sections during moving or installation, read the "Important Safety Precautions for Split Cabinet Feature" on page 5.
4. **Do not plug in any power cords** until AFTER you have connected all cables and devices to your TV.
5. **BEFORE connecting cables or devices to the TV, learn the functions** of the TV's connections and controls (pages 9 and 10).
6. **Connect your other electronic device(s) to the TV** (pages 12–25).
7. **Connect the G-LINK™ cable** (either one of the enclosed IR blaster cables) from your VCR and/or Cable box (if applicable) to the G-LINK jack so you can use the TV Guide On Screen® recording features. See page 25.
8. **Install the batteries in the remote control** (page 27).
9. **See "Learning about the remote control" for an overview of the buttons on the remote control** (page 26).
10. **Program the remote control to operate your other device(s)** (pages 27–33).
11. **AFTER connecting all cables and devices, plug in the power cords** for your TV and other devices.
12. **After you plug in the TV power cord, the green LED** (on the TV front panel, to the right of the POWER button) **will blink 3 times.** Wait about 30 seconds until the green LED lights continuously and then press POWER on the TV front panel or remote control.  
See "LED indications" on page 94.
13. **Press the TouchFocus® button on the TV front panel to automatically adjust the color convergence after setting up your TV.**  
See page 49 for details on adjusting the color convergence.
14. **See "Menu layout and navigation" for a quick overview on navigating the TV's menu structure** (pages 34–35).
15. **See Chapter 5 for details on setting up the TV Guide On Screen® system** (if available in your area).  
**Note: The TV Guide On Screen program guide opens automatically when you turn on the TV.**  
**To disable this feature:**
  - 1) Press TV GUIDE on the remote control to open the TV Guide On Screen system (if it is not already open).
  - 2) Use the ◀▶ buttons to select the SETUP menu.
  - 3) Use the ▲▼ buttons to select CHANGE DEFAULT OPTIONS, and then press ENTER.
  - 4) Use the ▲▼ buttons to select GENERAL DEFAULT OPTION, and then press ENTER.
  - 5) Set the AUTO GUIDE option to OFF.
  - 6) Use the ▲▼ buttons to select DONE, and then press ENTER.
16. **See Chapter 7 for details on using the TV Guide On Screen™ program guide** (if available in your area).
  - When using the TV Guide On Screen system to record a program for the first time, it is recommended that you perform a test recording to make sure your system is set up properly.
  - If the TV power cord is unplugged for an extended period of time, it may take up to 24 hours with the TV in standby mode (power cord plugged in and power OFF) to download the entire TV Guide On Screen program schedule. Be sure to follow the instructions under "TV Guide On Screen Reminder" on page 39.
17. **Program channels into the TV's channel memory** (page 41).
18. **Set up the TheaterNet™ on-screen device control feature** (if applicable to your particular home theater system components) (page 44).
19. **For details on using the memory card viewer, see page 84.**
20. **For details on using the TV's features, see Chapter 8.**
21. **For help, refer to the Troubleshooting Guide (Chapter 10).**
22. **For technical specifications, see Chapter 11.**
23. **For warranty information, see Chapter 11.**
24. **Enjoy your new TV!**

**Note: If the power is cut off while you are viewing the TV, the TV automatically turns on again when power is restored.** If the TV is on when a power failure occurs, the Last Mode Memory feature will cause the TV to turn on automatically after the power is restored. If you are viewing fixed images or special formats when the power fails, such images or formats may be displayed when the power returns. To prevent possible damage to the TV's picture tube, you should unplug the TV's power cord if it is possible that you will be away from the TV for an extended period of time after the power is restored. If you are away, the TV could turn on automatically, displaying fixed images or special formats that can become permanently engrained in the picture tube. **THIS TYPE OF DAMAGE IS NOT COVERED BY YOUR WARRANTY.** See item 33 on page 4.

**Note:** If you sell or transfer this television to a third party, be sure to reset the PIN code as described on page 88 under the heading, "If you cannot remember your PIN code."



## 2 Connecting your TV

### TV front panel controls and connections

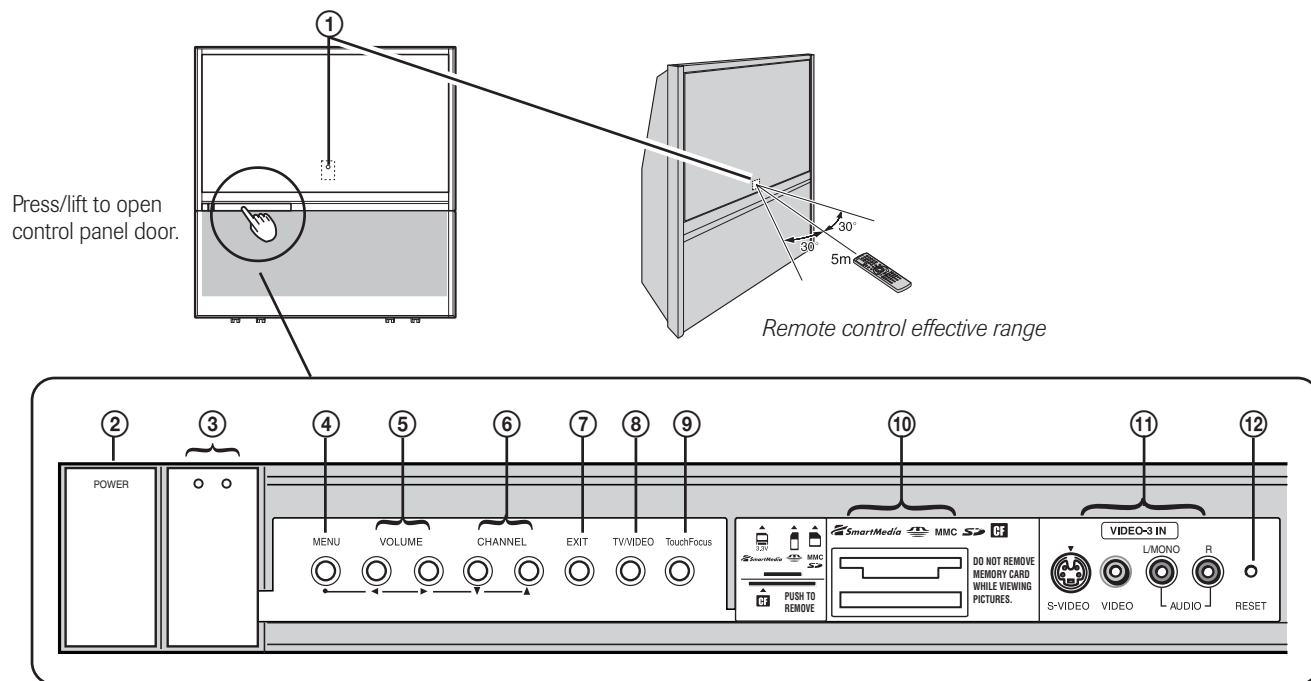

- ① **Remote control sensor** (behind the screen) — Point the remote control toward this area of the TV screen.
- ② **POWER** — Press to turn the TV on and off.
- ③ **Red and Green LEDs** — When green lights solid (not blinking), it indicates that the TV power cord is plugged in and the power is OFF. This is called standby mode.  
*NOTE: When you first plug in the power cord, the green LED will blink 3 times. After approximately 30 seconds, the green LED will light continuously, at which point you can press POWER to turn ON the TV.*  
When red lights solid (not blinking), it indicates that the TV power cord is plugged in and the POWER is ON.  
See “LED indications” on page 94 for additional information.
- ④ **MENU** — Press to access the menu system (see page 34). When a menu is on-screen or the TV Guide On Screen program guide is open, this button functions as the ENTER button.
- ⑤ **VOLUME** ◀▶ — When no menu is on-screen, these buttons adjust the volume level. When a menu is on-screen, these buttons function as left/right menu navigation buttons.
- ⑥ **CHANNEL** ▲▼ — When no menu is on-screen, these buttons change the channel (programmed channels only; see page 41). When a menu is on-screen, these buttons function as up/down menu navigation buttons.
- ⑦ **EXIT** — Press to close an on-screen menu instantly.
- ⑧ **TV/VIDEO** — Repeatedly press to change the source you are viewing (ANT 1, ANT 2, VIDEO 1, VIDEO 2, VIDEO 3, HDMI, ColorStream HD1, ColorStream HD2).
- ⑨ **TouchFocus**® — Press to automatically adjust the color convergence (see page 49).
- ⑩ **Memory card slots** — Insert a memory card (SD, SmartMedia,™ MMC, Memory Stick,™ CompactFlash®) into one of the memory card slots to view JPEG files (such as photos) as a “slide show” on your TV (see page 84).
- ⑪ **VIDEO-3** — The front panel A/V connections are referred to as “VIDEO 3” and include standard A/V connections plus optional S-video. (The VIDEO 1 and VIDEO 2 A/V connections are on the TV’s back panel; see page 10.)
- ⑫ **RESET** — If the TV stops responding to the controls on the remote control or TV front panel and you cannot turn off the TV, press this button to reset the TV.  
*NOTE: The RESET button is recessed, so you will need to use the end of a paper clip or similar object to press the button.*

## TV back panel connections

For an explanation of cable types, see page 11.

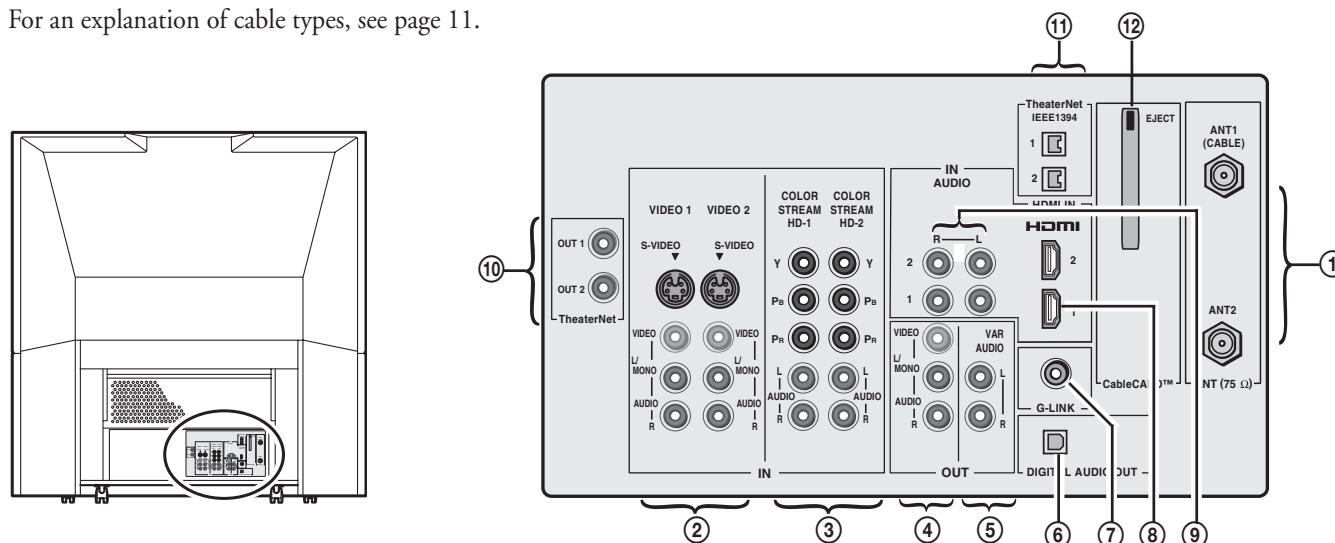

- ① **ANT-1 (CABLE) IN and ANT-2 IN** — Two inputs that support analog (NTSC) and digital (ATSC) off-air antenna signals and analog and digital (QAM) Cable TV signals.  
**Note:** If you have an antenna only, connect it to ANT-1. If you have both Cable TV and an antenna, connect the Cable TV to ANT-1 and the antenna to ANT-2.
- ② **VIDEO 1 IN and VIDEO 2 IN** — Two sets of standard (composite) video and standard audio inputs plus optional S-video inputs for connecting devices with composite video or S-video output.  
**NOTE:** Standard (composite) video and S-video cables carry only video information; separate audio cables are required for a complete connection.
- ③ **ColorStream® HD-1 and ColorStream® HD-2** — Two sets of ColorStream® high-definition component video and standard stereo audio inputs for connecting devices with component video output, such as a Toshiba DVD player with ColorStream®. See pages 15 and 17.  
**Note:** Component video cables carry only video information; separate audio cables are required for a complete connection.
- ④ **A/V OUT** — Standard composite video and analog audio outputs for connecting a VCR for editing and dubbing. See page 18 for details.
- ⑤ **Variable Audio OUT** — Standard analog audio outputs for connecting an analog amplifier with external speakers. See page 20.
- ⑥ **Digital Audio OUT** — Optical audio output in Dolby Digital or PCM (pulse-code modulation) format for connecting an external Dolby Digital decoder, amplifier, AV receiver, or home theater system with optical audio input. See page 20.
- ⑦ **G-LINK™** — For use with one of the enclosed IR blaster/G-LINK cables to enable the TV Guide On Screen® recording features. See page 25.
- ⑧ **Two Sets HDMI™ IN** — High-Definition Multimedia Interface input receives digital audio and uncompressed digital video from an HDMI device or uncompressed digital video from a DVI device. See page 19.  
**NOTE: NEVER CONNECT THIS TV TO A PERSONAL COMPUTER (PC).** This TV is not intended for use with a PC.
- ⑨ **Standard Audio IN 1 and Audio IN 2** — Two sets of standard audio inputs for use when connecting a DVI device with analog audio output to the HDMI input. See page 19.
- ⑩ **TheaterNet™ (IR) OUT** — For controlling infrared remote-controlled devices through the TV. You can connect up to two devices with either one of the enclosed IR blaster cables, and then control the devices using the TV's IR pass-through or TheaterNet™ (on-screen device control) features. See pages 21 and 44.
- ⑪ **IEEE-1394** — Two bi-directional digital IEEE-1394 ports for connecting multiple devices with compressed digital video. Because these ports are bi-directional, they can be used for playback and recording. You can control your IEEE-1394 devices using the TV's TheaterNet on-screen control icons. See pages 21–24 and 44.  
**NOTE:**
  - IEEE-1394 cable carries both audio and video information; no separate audio cables are required for a complete connection.
  - **NEVER CONNECT THIS TV TO A PERSONAL COMPUTER (PC).** This TV is not intended for use with a PC.
- ⑫ **CableCARD™ slot** — For use with a digital security card and digital Cable TV service (provided by your local Cable operator) to view encrypted digital programming. See pages 12 and 51.

HDMI, the HDMI logo, and High-Definition Multimedia Interface are trademarks or registered trademarks of HDMI Licensing, LLC.

CableCARD is a trademark of Cable Television Laboratories, Inc.

## Overview of cable types



**NOTE: NEVER CONNECT THIS TV TO A PERSONAL COMPUTER (PC).**  
THIS TV IS NOT INTENDED FOR USE WITH A PC.

**Note:** Two dual-wand IR blaster/G-LINK cables are included with your TV. All other required cables, if not provided with your other devices, can be purchased at many electronics accessory suppliers.

- **Coaxial (F-type) cable** is used for connecting your antenna, cable TV service, and/or cable converter box to the ANT-1 and/or ANT-2 RF inputs on your TV.
- **Standard A/V cables (composite video)** usually come in sets of three, and are for use with video devices with standard audio and standard (composite) video output. These cables (and the related inputs on your TV) are typically color-coded according to use: yellow for video, red for stereo right audio, and white for stereo left (or mono) audio.
- **S-video cable** is for use with video devices with S-video output. Separate audio cables are required for a complete connection.
 

**Note:** An S-video cable provides better picture performance than a composite video cable. If you connect an S-video cable, be sure to disconnect the standard (composite) video cable or the picture performance will be unacceptable.
- **Component video cables** come in sets of three and are for use with video devices with component video output. (ColorStream® is Toshiba's brand of component video.) These cables are typically color-coded red, green, and blue. Separate audio cables are required for a complete connection.
 

**Note:** Component video cables provide better picture performance than a standard (composite) video or S-video cable.
- **HDMI cable** is for use with devices with HDMI (high-definition multimedia interface) output. HDMI cable delivers digital audio and video in its native format. This cable carries both video and audio information; therefore, no separate audio cables are required for a complete HDMI device connection. See page 19 for further details.
 

**Note:** HDMI cable provides better picture performance than a standard (composite) video or S-video cable.
- **IEEE-1394 cable** is for use with video devices with compressed digital video output that meets CEA specifications for IEEE-1394. This cable carries both video and audio information; therefore, no separate audio cables are required for a complete connection. See pages 22–24.

**Note:**

- The transmission capability of IEEE-1394 cable used with this TV must be S400 (400 Mbps maximum).
- IEEE-1394 cable provides better picture performance than a standard (composite) video or S-video cable.

- **Dual-wand IR blaster/G-LINK™ cable** is for use with video devices with IR (infrared) remote control. Two of these cables are included with your TV. One is for connection to the G-LINK jack (page 25) to enable TV Guide On Screen™ recording features (Chapters 5 and 7). The other can be used with the TV's IR pass-through feature (page 21) and TheaterNet on-screen device control feature (page 44).

**Note:** The two IR blaster/G-LINK cables included with your TV have specific characteristics that allow them to work properly with this TV's IR OUT and G-LINK ports. **Never use other aftermarket IR blaster or G-LINK cables with this TV.** Other cables may not function properly and can cause damage. THIS TYPE OF DAMAGE IS NOT COVERED BY YOUR TOSHIBA WARRANTY.

- **Optical audio cable** is for connecting receivers with Dolby® Digital or PCM (pulse-code modulation) optical audio input to the TV's DIGITAL AUDIO OUT jack. See page 20.

Dolby is a registered trademark of Dolby Laboratories.

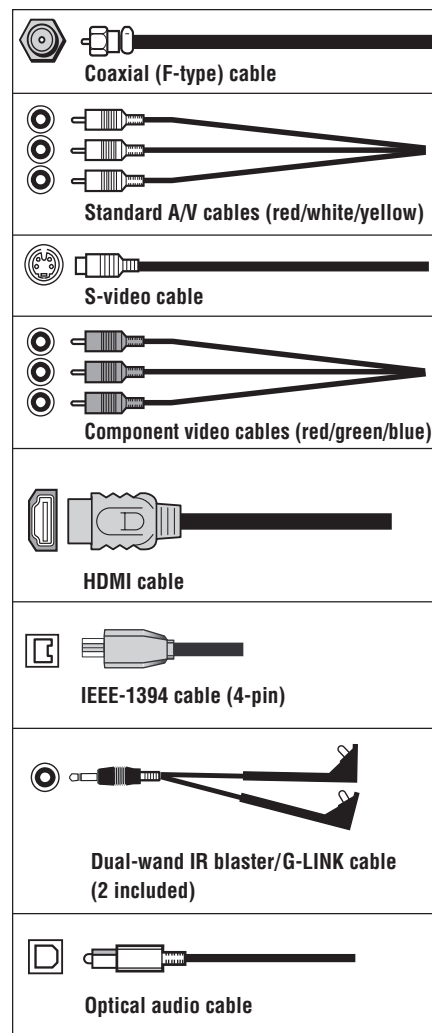

**Note:** Although your TV includes both HDMI and IEEE-1394 connections, it may not operate with another device you have that includes such a connection. For example, the IEEE-1394 ports are not intended to operate with current model Mini DV camcorders, and the HDMI input is not intended for connection to a computer. Copyright protection requirements may also prohibit or limit connectivity. See page 19 for details about the HDMI input. See pages 22–24 for details about the IEEE-1394 ports.

## About the connection illustrations

You can connect different types and brands of devices to your TV in several different configurations. The connection illustrations in this manual are representative of typical device connections only. The input/output jacks on your devices may differ from those illustrated herein. For details on connecting and using your specific devices, refer to each device's owner's manual.

## Connecting a digital CableCARD™

This digital television is capable of receiving analog basic, digital basic, and digital premium cable television programming by direct connection to a Cable system providing such programming.

A security card (such as a digital CableCARD™), provided by your Cable operator, is required to view encrypted digital programming.

Certain advanced and interactive digital cable services (such as video-on-demand, a Cable operator's enhanced program guide, and data-enhanced television services) will not work with the use of a CableCARD and may require the use of a separate set-top box from your Cable operator.

For more information, call your local Cable operator.

### You will need:

- ▶ one digital CableCARD (contact your Cable operator)
- ▶ digital Cable subscription service (contact your Cable operator)

### To view encrypted digital channels:

1. Connect your digital Cable TV cable to ANT-1.
2. With the front of the CableCARD™ facing right, insert it into the CableCARD slot on the back of the TV (see illustration below left).
3. After the CableCARD is inserted, a CableCARD option appears in the APPLICATIONS menu, with informational screens provided by your digital CableCARD service. See page 51 for additional information.

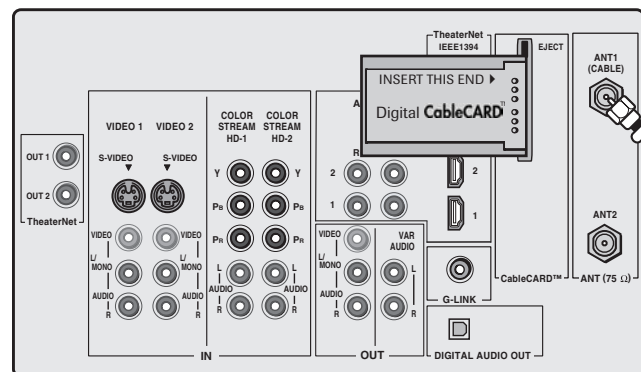
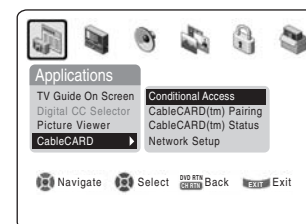
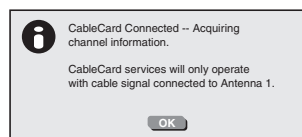

From digital Cable service (connect to ANT 1 only)

### NOTE:

- Never remove the CableCARD carelessly. Be sure to use the EJECT button when removing the CableCARD.
- Never insert any object or card (including, without limitation, a PCMCIA card) other than a CableCARD into the CableCARD slot.
- Always make sure the CableCARD is facing the correct direction.
- Connect the cable for your digital Cable TV service to ANT-1 only.
- A digital Cable subscription is required to use a CableCARD. Contact your Cable company for information.
- If the TV locks up with the CableCARD inserted, press the RESET button on the TV front or unplug the TV, plug it in again, and press POWER.
- When using a CableCARD, channel programming (page 41) is unnecessary because the CableCARD automatically loads the Cable channel list into the TV's channel memory.
- The CableCARD will take several seconds to "pair" with the TV. CableCARD information and channel listings will not be available until this "pairing" process is completed.

CableCARD is a trademark of Cable Television Laboratories, Inc.



## Connecting a VCR and antenna or Cable TV (no Cable box)

### You will need:

- ▶ one coaxial cable
- ▶ one set of standard A/V cables
  - For better picture performance, if your VCR has S-video, use an S-video cable (plus the audio cables) instead of the standard video cable. However, do not connect both types of video cables to VIDEO 1 (or VIDEO 2) at the same time or the picture performance will be unacceptable.
  - If you have a mono VCR, connect L/MONO on the TV to your VCR's audio out jack using the white audio cable only.

#### To view the antenna or Cable signal:

Turn OFF the VCR.

Select the ANT 1 video input source.\*

#### To view the VCR:

Turn ON the VCR. Select the VIDEO 1 video input source on the TV.\*

or... Turn ON the VCR. Select the ANT 1 video input source.\*  
Tune the TV to channel 3 or 4 (whichever channel is vacant in your area).

#### To use the TV Guide On Screen recording features:

1. Connect the G-LINK cable according to the instructions on page 25.
2. Make sure the VCR is connected to the A/V OUT jacks on the TV (see illustration).
3. Set the VCR to the appropriate line input (refer to your VCR owner's manual for details), and then turn OFF the VCR.
4. See Chapter 5 for details on setting up the TV Guide On Screen system.
5. See Chapter 7 for details on using the TV Guide On Screen system.

### Stereo VCR

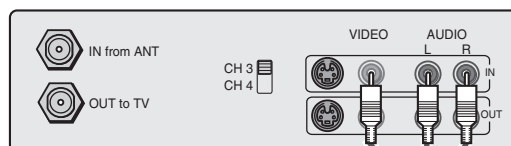

### TV

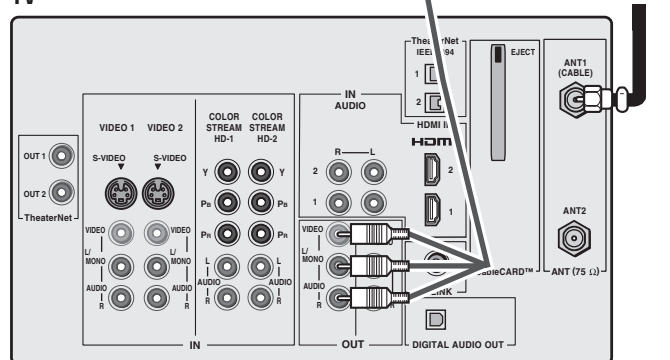

**Note:** The VIDEO/AUDIO OUT jacks output the signals from the ANT 1, ANT 2, VIDEO 1, VIDEO 2, or VIDEO 3 jacks when the appropriate input mode is selected.

**The unauthorized recording, use, distribution, or revision of television programs, videotapes, DVDs, and other materials is prohibited under the Copyright Laws of the United States and other countries, and may subject you to civil and criminal liability.**

## Connecting a camcorder

### You will need:

- ▶ one set of standard A/V cables
  - For better picture performance, if your camcorder has S-video, use an S-video cable (plus the audio cables) instead of the standard video cable. Do not connect both an S-video cable and a standard video cable to VIDEO 3 at the same time or the picture performance will be unacceptable.

#### To view the camcorder video:

Select the VIDEO 3 video input source.\*

\* To select the video input source, press INPUT on the remote control (see page 67).  
To program the TV remote control to operate other devices, see Chapter 3.

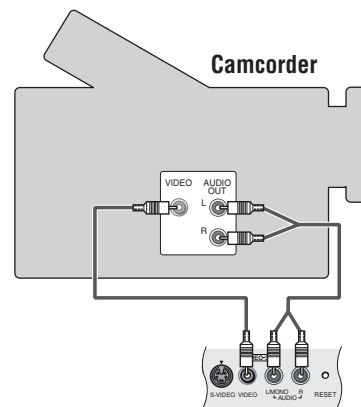

VIDEO 3 inputs on TV front panel

## Connecting a VCR and Cable box

### You will need:

- ▶ one Cable signal splitter
- ▶ five coaxial cables
- ▶ two sets of standard A/V cables
  - For better picture performance from your VCR: If your VCR has S-video, connect an S-video cable (plus the audio cables) instead of the standard video cable. Do not connect an S-video cable and a standard video cable to VIDEO 1 (or VIDEO 2) at the same time or the picture performance will be unacceptable.
  - If you have a mono VCR, connect L/MONO on the TV to your VCR's audio out jack using the white audio cable only.
  - For better picture performance from your Cable box: If your Cable box has component video, you can connect component video cables (plus the audio cables) instead of the standard video cable from the Cable box to the ColorStream HD-1 inputs on the TV. You would then select ColorStream HD-1 as the video input source.\*
  - When you use a Cable box, you may not be able to use the remote control to program or access certain features on the TV.

### To view basic Cable channels and use the TV's features:

Select the ANT 2 video input source.\* Use the TV front panel controls or remote control to change channels and access the TV's features.

### To view basic and premium Cable channels:

Turn OFF the VCR. Select the ANT 1 video input source.\* Tune the TV to channel 3 or 4 (whichever channel is vacant in your area). Use the Cable box controls to change channels.

or... Turn ON the VCR. Tune the VCR to channel 3 or 4 (whichever channel is vacant in your area). Select the VIDEO 1 video input source.\* Use the Cable box controls to change channels.

### To view the VCR:

Turn ON the VCR. Select the VIDEO 1 video input source.\*

**Note:** This will provide better picture performance if you connected an S-video cable as mentioned in the first bulleted item on this page.

or... Turn ON the VCR. Select the ANT 1 video input source.\* Tune the TV to channel 3 or 4 (whichever channel is vacant in your area).

\* To select the video input source, press INPUT on the remote control (see page 67). To program the TV remote control to operate other devices, see Chapter 3.

**The unauthorized recording, use, distribution, or revision of television programs, videotapes, DVDs, and other materials is prohibited under the Copyright Laws of the United States and other countries, and may subject you to civil and criminal liability.**

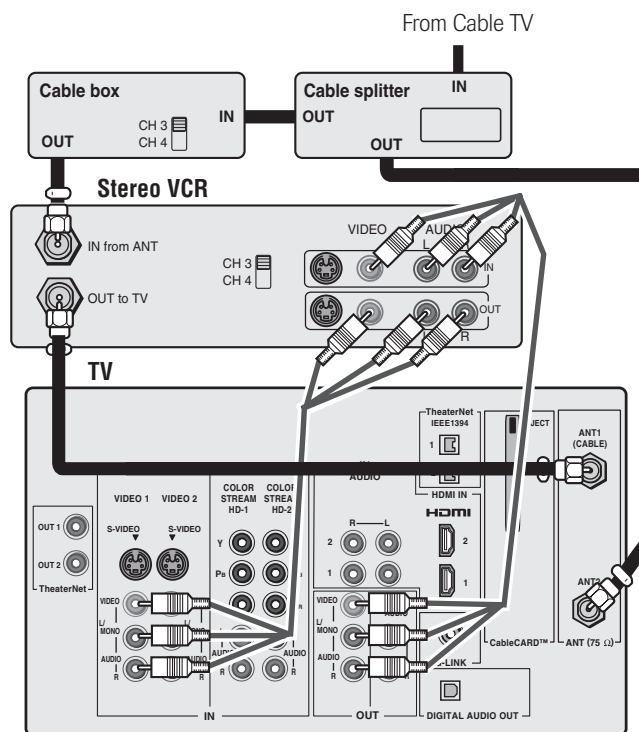

**Note:** The VIDEO/AUDIO OUT jacks output the signals from the ANT 1, ANT 2, VIDEO 1, VIDEO 2, or VIDEO 3 jacks when the appropriate input mode is selected.

### To enable the TV Guide On Screen system to work with your cable box and to use the TV Guide On Screen recording features:

1. Connect the G-LINK cable according to the instructions on page 25.
2. Make sure the VCR is connected to the A/V OUT jacks on the TV (see illustration).
3. Set the VCR to the appropriate line input (refer to your VCR owner's manual for details), and then turn OFF the VCR.
4. See Chapter 5 for details on setting up the TV Guide On Screen system.
5. See Chapter 7 for details on using the TV Guide On Screen system.

## Connecting a VCR and satellite receiver

**Note:** The TV Guide On Screen® system does not receive program listings from or for any satellite service.

### You will need:

- ▶ three coaxial cables
- ▶ one set of component video cables (if your satellite receiver does not have component video, connect the standard A/V cables only)
- ▶ three sets of standard A/V cables
  - For better picture performance, if your satellite receiver and VCR have S-video, connect S-video cables (plus the audio cables) instead of the standard video cables. Do not connect both types of video cable to VIDEO 1 (or VIDEO 2) at the same time or the picture performance will be unacceptable.
  - If you have a mono VCR, connect L/MONO on the TV (VIDEO 1) to your VCR's AUDIO OUT jack using the white audio cable only.

### To view satellite programs using the component video connections:

Select the ColorStream HD-1 video input source on the TV.\*

### To view satellite programs using the standard

#### video connections or to record satellite programs:

Turn on all three devices. Set the VCR to the appropriate line input (refer to your VCR owner's manual for details). Select the VIDEO 2 video input source on the TV.\*

### To view the VCR or view and record antenna channels:

Turn ON the VCR. Select the ANT-1 video input source on the TV.\*  
Tune the TV to channel 3 or 4 (whichever channel is vacant in your area).

or... Turn ON the VCR. Tune the VCR to the channel you want to watch. Select the VIDEO 1 video input source on the TV.\*

\* To select the video input source, press INPUT on the remote control (see page 67). To program the TV remote control to operate other devices, see Chapter 3.

The unauthorized recording, use, distribution, or revision of television programs, videotapes, DVDs, and other materials is prohibited under the Copyright Laws of the United States and other countries, and may subject you to civil and criminal liability.

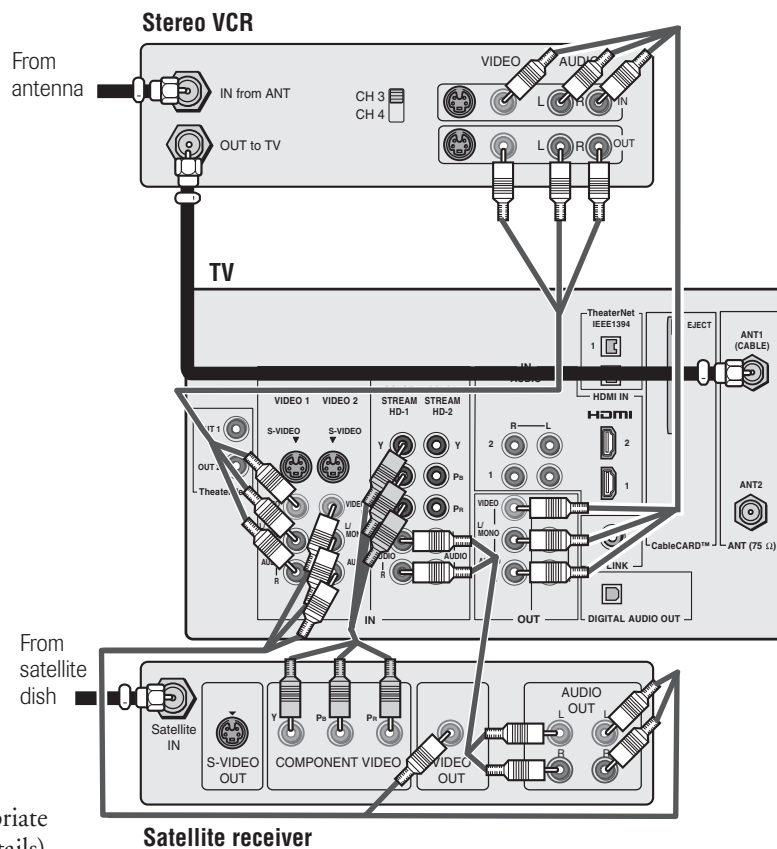

**Note:** The VIDEO/AUDIO OUT jacks output the signals from the ANT 1, ANT 2, VIDEO 1, VIDEO 2, or VIDEO 3 jacks when the appropriate input mode is selected.

### To use the TV Guide On Screen recording features:

1. Connect the G-LINK cable according to the instructions on page 25.
2. Make sure the VCR is connected to the A/V OUT jacks on the TV (see illustration).
3. Set the VCR to the appropriate line input (refer to your VCR owner's manual for details), and then turn OFF the VCR.
4. See Chapter 5 for details on setting up the TV Guide On Screen system.
5. See Chapter 7 for details on using the TV Guide On Screen system.

## Connecting a DVD player with S-video, a VCR, and a Cable box

### You will need:

- ▶ five coaxial cables
  - ▶ two sets of standard A/V cables
- Note:** If you have a mono VCR, connect L/MONO on the TV (VIDEO 1) to your VCR's audio out jack using the white audio cable only.

- ▶ one S-video cable
- ▶ one pair of standard audio cables

**Note:**

- If your DVD player does not have S-video, use a standard video cable instead. Do not connect an S-video cable and a standard video cable to VIDEO 1 (or VIDEO 2) at the same time or the picture performance will be unacceptable.
- If your DVD player has component video, see page 17.
- Do not connect the DVD player and VCR to the same set of A/V inputs on the TV. (See the illustration, which shows the VCR connected to VIDEO 1 on the TV, and the DVD player connected to VIDEO 2.)

- To view basic channels and access the TV's features:**  
Select the ANT 2 video input source.\* Use the TV controls to change channels and access the TV's features.

- To view premium Cable channels:**  
Turn OFF the VCR. Select the ANT 1 video input source.\* Tune the TV to channel 3 or 4 (whichever channel is vacant in your area). Use the Cable box controls to change channels.

or... Turn ON the VCR. Tune the VCR to channel 3 or 4 (whichever channel is vacant in your area). Select the VIDEO 1 video input source.\* Use the Cable box controls to change channels.

**Note:** When you use a Cable box, you may not be able to use the remote control to program or access certain features on the TV.

- To view the DVD player:**  
Turn ON the DVD player. Select the VIDEO 2 video input source.\*

- To view VCR 1:**  
Turn ON the VCR. Select the VIDEO 1 video input source on the TV.\*

or... Turn ON the VCR. Select the ANT 1 video input source.\* Tune the TV to channel 3 or 4 (whichever channel is vacant in your area).

\* To select the video input source, press INPUT on the remote control (see page 67). To program the TV remote control to operate other devices, see Chapter 3.

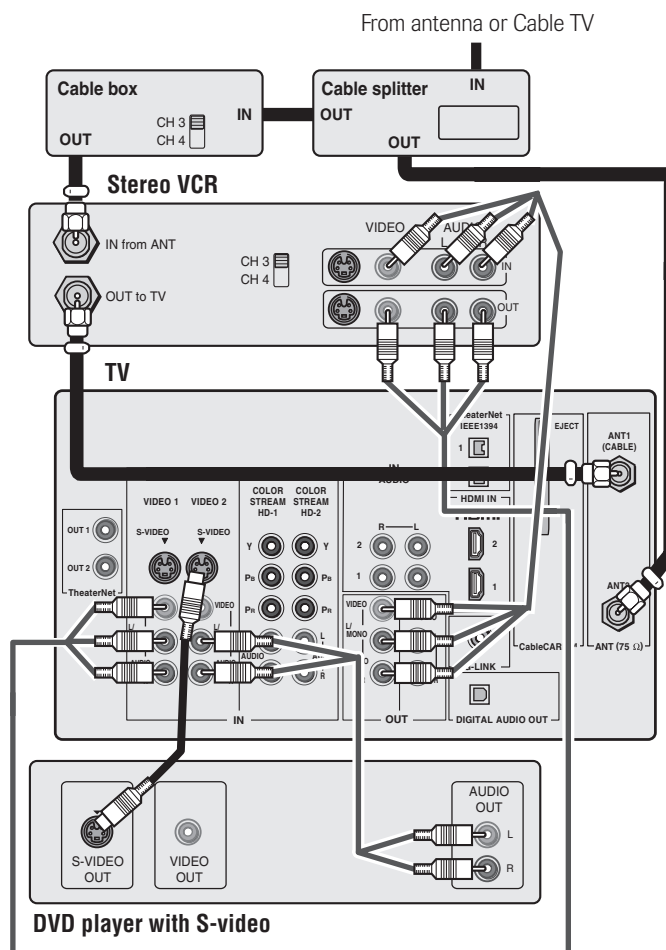

**Note:** The VIDEO/AUDIO OUT jacks output the signals from the ANT 1, ANT 2, VIDEO 1, VIDEO 2, or VIDEO 3 jacks when the appropriate input mode is selected.

- To enable the TV Guide On Screen system to work with your cable box and to use the TV Guide On Screen recording features:**
  1. Connect the G-LINK cable according to the instructions on page 25.
  2. Make sure the VCR is connected to the A/V OUT jacks on the TV (see illustration).
  3. Set the VCR to the appropriate line input (refer to your VCR owner's manual for details), and then turn OFF the VCR.
  4. See Chapter 5 for details on setting up the TV Guide On Screen system.
  5. See Chapter 7 for details on using the TV Guide On Screen system.

**The unauthorized recording, use, distribution, or revision of television programs, videotapes, DVDs, and other materials is prohibited under the Copyright Laws of the United States and other countries, and may subject you to civil and criminal liability.**



## Connecting a DVD player with ColorStream® (component video) and a VCR

Your TV has ColorStream® (component video) inputs. Connecting a DVD player with component video output (such as a Toshiba DVD player with ColorStream®) can greatly enhance picture quality.

### You will need:

- ▶ two coaxial cables
- ▶ two sets of standard A/V cables
  - For better picture performance, if your VCR has S-video, use an S-video cable (plus the audio cables) instead of the standard video cable. However, do not connect both types of video cable to VIDEO 1 (or VIDEO 2) at the same time or the picture performance will be unacceptable.
  - If you have a mono VCR, connect L/MONO on the TV (VIDEO 1) to your VCR's audio out jack using the white audio cable only.
- ▶ one pair of standard audio cables
- ▶ one set of component video cables
  - You can connect the component video cables (plus audio cables) from the DVD player to either set of ColorStream jacks on the TV (HD-1 or HD-2). The ColorStream HD-1 and HD-2 jacks can be used with Progressive (480p, 720p) and Interlaced (480i, 1080i) scan systems. A 1080i signal will provide the best picture performance.
  - If your DVD player does not have component video, see page 16. If your DVD player has HDMI video, see page 19.

### To view antenna or Cable channels:

Turn OFF the VCR. Select the ANT 1 video input source on the TV.\*

### To view the DVD player:

Turn ON the DVD player. Select the ColorStream HD-1 video input source on the TV.\*

### To view the VCR:

Turn ON the VCR. Select the VIDEO 1 video input source on the TV.\*

or... Turn ON the VCR. Select the ANT 1 video input source.\*  
Tune the TV to channel 3 or 4 (whichever channel is vacant in your area).

### To record a TV program while watching a DVD:

Turn ON the VCR. Tune the VCR to the channel to record. Select the ColorStream HD-1 video input source on the TV\* to view the DVD.

\* To select the video input source, press INPUT on the remote control (see page 67). To program the TV remote control to operate other devices, see Chapter 3.

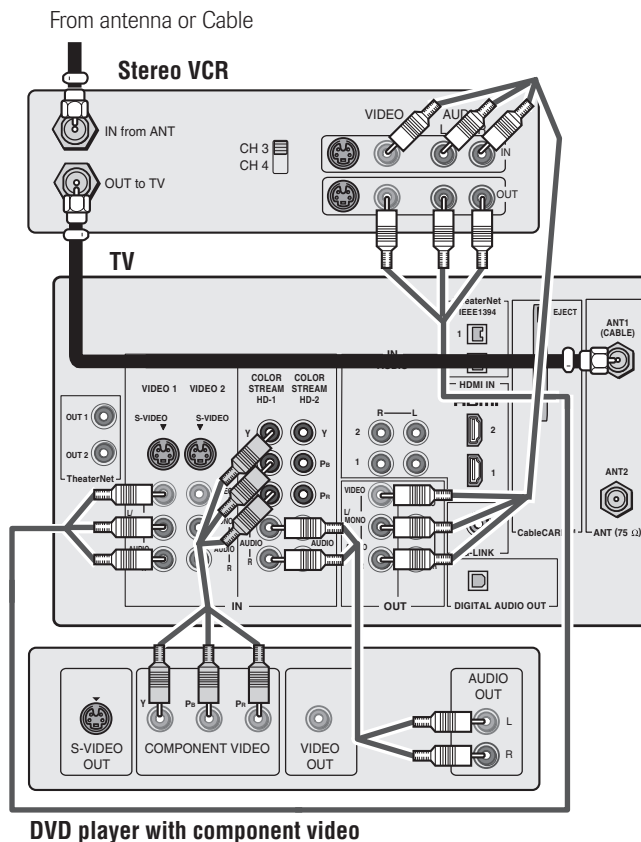

**Note:** The VIDEO/AUDIO OUT jacks output the signals from the ANT 1, ANT 2, VIDEO 1, VIDEO 2, or VIDEO 3 jacks when the appropriate input mode is selected.

### To use the TV Guide On Screen recording features:

1. Connect the G-LINK cable according to the instructions on page 25.
2. Make sure the VCR is connected to the A/V OUT jacks on the TV (see illustration).
3. Set the VCR to the appropriate line input (refer to your VCR owner's manual for details), and then turn OFF the VCR.
4. See Chapter 5 for details on setting up the TV Guide On Screen system.
5. See Chapter 7 for details on using the TV Guide On Screen system.

The unauthorized recording, use, distribution, or revision of television programs, videotapes, DVDs, and other materials is prohibited under the Copyright Laws of the United States and other countries, and may subject you to civil and criminal liability.

## Connecting two VCRs

### You will need:

- ▶ two coaxial cables
- ▶ two sets of standard A/V cables
  - For better picture performance, if VCR 1 has S-video, use an S-video cable (plus the audio cables) instead of the standard video cable. However, do not connect both types of video cable to VIDEO 1 (or VIDEO 2) at the same time or the picture performance will be unacceptable.
  - If VCR 1 has mono audio, connect L/MONO on the TV (VIDEO 1) to the audio out jack on VCR 1 using the white audio cable only.
  - Do not connect the same VCR to the output and input jacks on the TV at the same time.

#### To view the antenna or Cable signal:

Turn OFF VCR 1. Select the ANT-1 video input source.\*

#### To view VCR 1:

Turn ON VCR 1. Select the VIDEO 1 video input source.\*

#### To dub or edit from VCR 1 to VCR 2:

Turn ON both VCRs. Set VCR 2 to the appropriate line input (refer to your VCR owner's manual for details).

Select the VIDEO 1 video input source.\*

#### Note:

- If you have a Cable box, connect the Cable box and splitter to VCR1 as shown on page 14.
- The VIDEO OUT signal incorporates Macrovision® copyright protection technology, which may prevent you from recording certain copy-restricted video materials.\*\*

\* To select the video input source, press INPUT on the remote control (see page 67). To program the TV remote control to operate other devices, see Chapter 3.

\*\*This product incorporates copyright protection technology that is protected by U.S. patents and other intellectual property rights. Use of this copyright protection technology must be authorized by Macrovision and is intended for home and other limited pay-per-view uses only, unless otherwise authorized by Macrovision. Reverse engineering or disassembly is prohibited. Macrovision is a registered trademark of Macrovision Corporation.

**The unauthorized recording, use, distribution, or revision of television programs, videotapes, DVDs, and other materials is prohibited under the Copyright Laws of the United States and other countries, and may subject you to civil and criminal liability.**

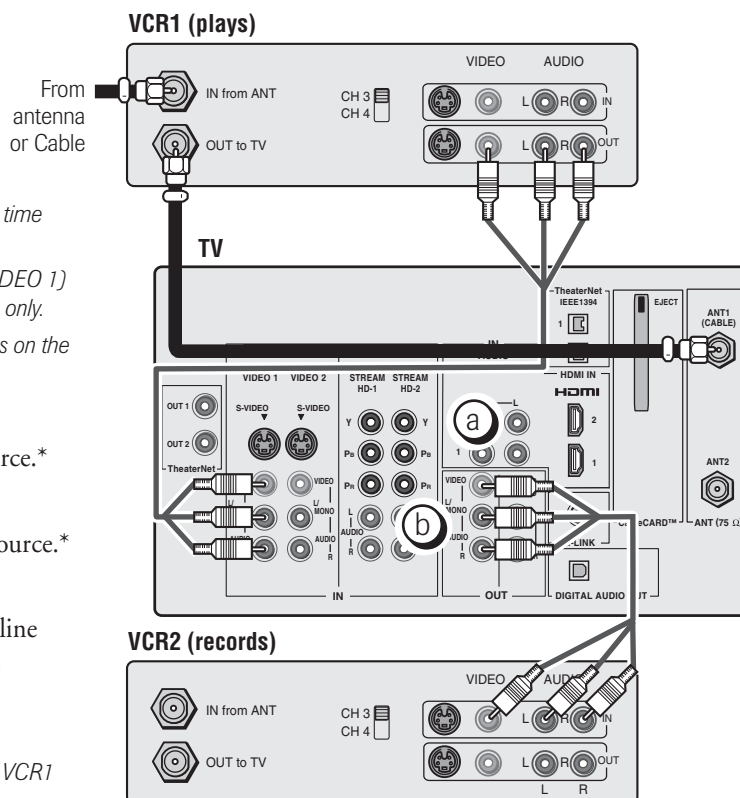

- a The VIDEO OUT jack does not output the POP picture.
- b When the POP window is open, the AUDIO OUT jacks output the sound of the active window (main or POP). For additional information, see "Notes about recording" on page 74.

**Note:** The VIDEO/AUDIO OUT jacks output the signals from the ANT 1, ANT 2, VIDEO 1, VIDEO 2, or VIDEO 3 jacks when the appropriate input mode is selected.

#### To use the TV Guide On Screen recording features:

**Note:** If you connect your devices according to the illustration above, you will record from the TV Guide On Screen system to the VCR labeled "VCR2."

1. Connect the G-LINK cable according to the instructions on page 25.
2. Make sure the VCR2 is connected to the A/V OUT jacks on the TV (see illustration).
3. Set the VCR to the appropriate line input (refer to your VCR owner's manual for details), and then turn OFF the VCR.
4. See Chapter 5 for details on setting up the TV Guide On Screen system.
5. See Chapter 7 for details on using the TV Guide On Screen system.

## Connecting an HDMI™ or a DVI device to the HDMI input

The HDMI<sup>[1]</sup> input on your TV receives digital audio and uncompressed digital video from an HDMI device or uncompressed digital video from a DVI<sup>[2]</sup> device.

This input is designed to accept HDCP<sup>[3]</sup> program material in digital form from EIA/CEA-861/861B-compliant<sup>[4]</sup> consumer electronic devices (such as a set-top box or DVD player with HDMI or DVI output).

The HDMI input is designed for best performance with 1080i high-definition video signals, but will also accept and display 480i, 480p, and 720p signals.



**NOTE: NEVER CONNECT THIS TV TO A PERSONAL COMPUTER (PC).**  
THIS TV IS NOT INTENDED FOR USE WITH A PC.

### To connect HDMI devices, you will need:

- one HDMI cable (type A connector for each device)

For proper operation, it is recommended that you use as short an HDMI cable as possible. You should not encounter difficulty if you use an HDMI cable shorter than 16.4 ft (5m).

HDMI cable transfers both video and audio. Separate analog audio cables are not required (see illustration below). Some CDVs (video CDs) may not output digital audio signals. In that case, you may hear sound by connecting analog audio cables. However, if you connect analog audio cables with this connection, the HDMI digital terminal on the TV will not receive the HDMI digital audio signal and you will hear analog audio only.

See "Selecting the HDMI 1 or HDMI 2 audio mode" on page 50.

#### HDMI device

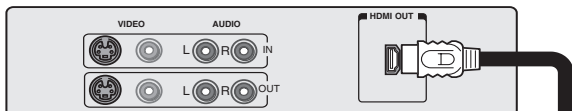

#### TV

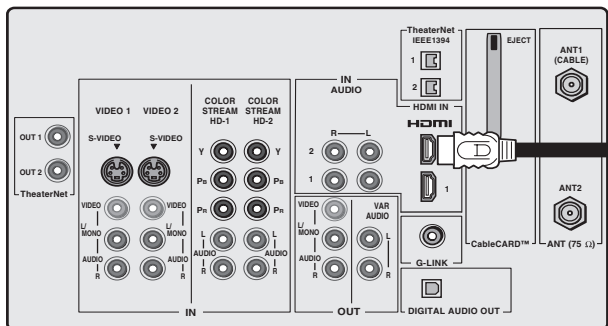

HDMI, the HDMI logo, and High-Definition Multimedia Interface are trademarks or registered trademarks of HDMI Licensing, LLC.

[1] HDMI = High-Definition Multimedia Interface.

[2] DVI = Digital Video Interface.

[3] HDCP = High-bandwidth Digital Content Protection.

[4] EIA/CEA-861/861B compliance covers the transmission of uncompressed digital video with high-bandwidth digital content protection, which is being standardized for reception of high-definition video signals. Because this is an evolving technology, it is possible that some devices may not operate properly with the TV.

**NOTE:** To ensure that the HDMI or DVI device is reset properly, it is recommended that you follow these procedures:

- When turning on your electronic components, **turn on the TV first**, and then the HDMI or DVI device.
- When turning off your electronic components, **turn off the HDMI or DVI device first**, and then the TV.

**NOTE:** If your HDMI/DVI device is not working, make sure the device is plugged in to the corresponding HDMI IN port you are selecting.

### To connect DVI devices, you will need:

- one HDMI-to-DVI adapter cable (HDMI type A connector) for each device

For proper operation, the length of an HDMI-to-DVI adapter cable should not exceed 9.8 ft (3m). The recommended length is 6.6 ft (2m).

- one pair of standard analog audio cables for each device

An HDMI-to-DVI adapter cable transfers video only. Separate analog audio cables are required (see illustration below).

See "Selecting the HDMI 1 or HDMI 2 audio mode" on page 50.

#### DVI device

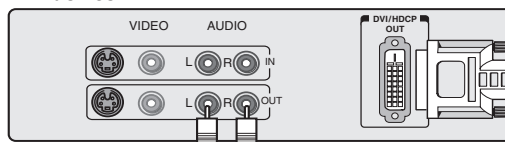

#### TV

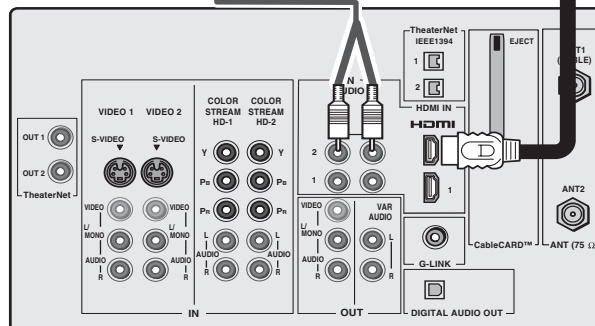

## Connecting a digital audio system

The TV's DIGITAL AUDIO OUT jack outputs a  or 2-channel down-mixed PCM (pulse-code modulation) signal for use with an external Dolby Digital decoder or other external audio system with optical audio input.

**You will need:**

- ▶ one optical audio cable

**To control the audio:**

Turn on the TV and the digital audio device. Press MENU on the TV's remote control and open the AUDIO menu. Highlight AUDIO SETUP and press ENTER. In the OPTICAL OUTPUT FORMAT field, select either DOLBY DIGITAL or PCM, depending on your device (see "Selecting the optical audio output format" on page 83).

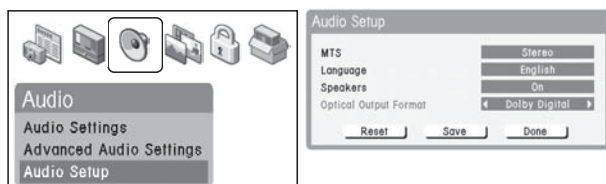

Turn off the TV's built-in speakers in the same AUDIO SETUP menu (above). Also see "Turning off the built-in speakers" on page 82.

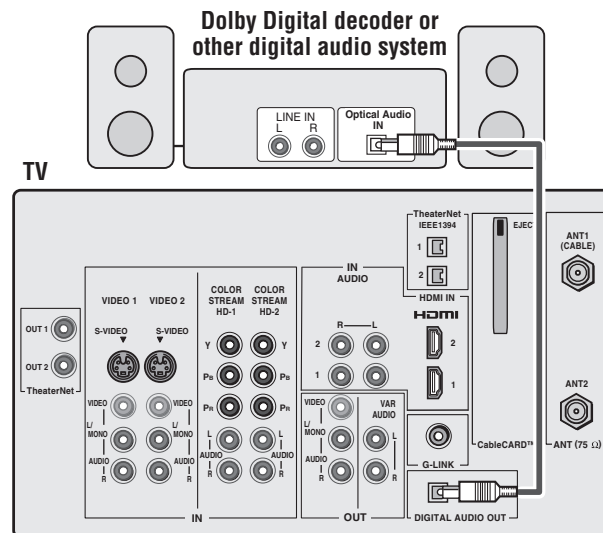

**Note:**

- Some audio systems may not be compatible with Dolby Digital bitstream signals. Older audio systems that are not compatible with standard optical out signals may not work properly, creating a high noise level that may damage speakers or headphones. **THIS DAMAGE IS NOT COVERED BY YOUR WARRANTY.**
- The DIGITAL AUDIO OUT jack may not output some digital audio sources because of copy restrictions.

The unauthorized recording, use, distribution, or revision of television programs, videotapes, DVDs, and other materials is prohibited under the Copyright Laws of the United States and other countries, and may subject you to civil and criminal liability.

## Connecting an analog audio system

This connection allows you to use external speakers with an external audio amplifier to adjust the sound level.

**You will need:**

- ▶ one pair of standard audio cables

**To control the audio:**

Turn on the TV and the stereo amplifier. Turn off the TV's built-in speakers (see "Turning off the built-in speakers" on page 82).

**Note:** To hear sound when using an external audio amplifier, the volume of both the TV and the amplifier must be set to a reasonable listening level.

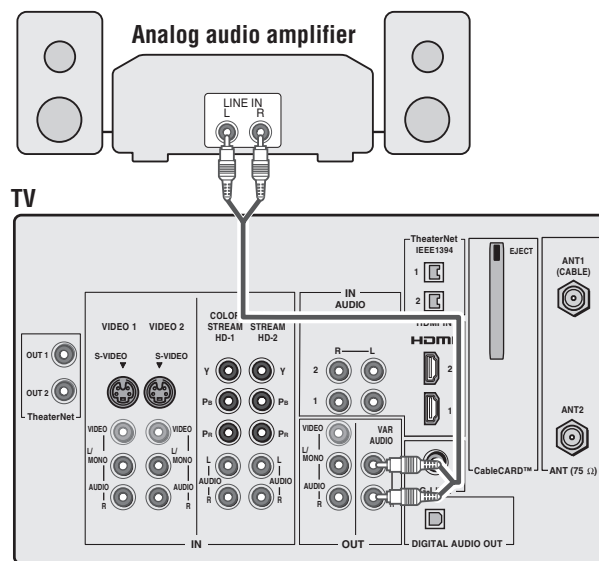



## Controlling infrared remote-controlled devices through the TV (IR pass-through)

You can use the TV's IR OUT jack (infrared pass-through) to remotely operate (through the TV) many infrared remote-controlled devices (such as a Toshiba infrared remote-controlled VCR or DVD player) enclosed within an entertainment center or similar cabinet. Without the IR OUT connection, the device typically would need to be visible to operate it remotely.

### You will need:

- ▶ one dual-wand IR blaster cable (included with your TV)
- ▶ other audio/video cables as required to connect the device(s) to the TV (see pages 12–20)

### To connect the IR blaster cable:

1. Locate the infrared sensor on the front of your device. This sensor is marked on some devices.\*
2. Align one of the IR blaster cable's wands about 1 inch away from the infrared sensor on the front of the device and attach it using double-sided mounting tape. If you have a second device, attach the second wand in a similar manner. (See illustration at right.)

**Note:** If you do not have a second device, coil the second wand with a rubber band and leave it behind the TV.

3. Plug the IR blaster cable's plug into one of the TV's TheaterNet OUT jacks.

### To control the device(s):

Point the TV remote control (programmed to operate the device; see Chapter 3) or the device's remote control at the front of the TV and press the button for the desired function. The signal passes from the remote control through the TV to the device via the IR blaster cable.

#### Note:

- If you use the device's remote control to operate the device, you also will need to use the TV's remote control to operate the TV.
- For additional control options, see "TheaterNet on-screen device control" at right.

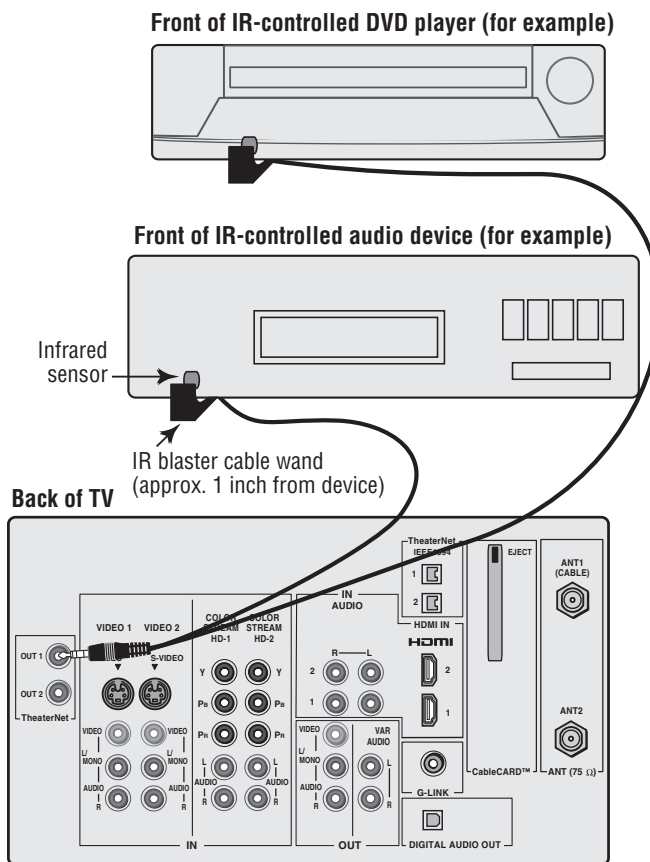
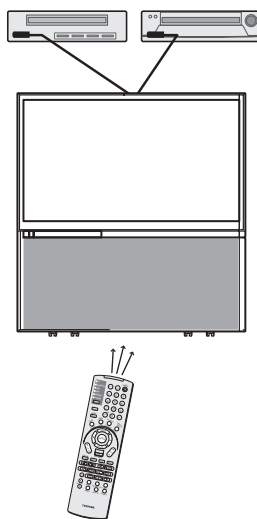

### TheaterNet™ on-screen device control

For additional control options for your home theater system, set up the TheaterNet on-screen device control feature. You can use this feature to control many IR remote-controlled devices and IEEE-1394 devices using the on-screen control icons.

See pages 44–48 for details on setting up and using TheaterNet.

See pages 22–24 for details on connecting IEEE-1394 devices.

**Note:** The TheaterNet icon controls are the only device functions available when the icons are on-screen. To access other device functions, close the TheaterNet icon window.

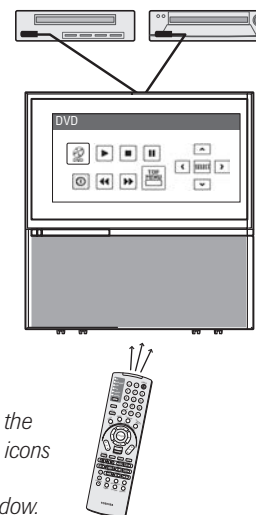

#### \*If you cannot locate the device's infrared sensor:

1. Turn OFF the device.
2. Starting at the lower left corner of the device, place the end of the device's remote control (with the infrared emitter) so it touches the front of the device and press POWER. (Do not use the TV's remote control for this step.)
3. If the device turns on, the place the remote control touched the device is the location of the sensor.
4. If the device does not turn on, move the remote control slightly to the right and press POWER again.
5. Repeat step 4 until you locate the device's infrared sensor.

## Connecting IEEE-1394 video devices

You can use the two bi-directional IEEE-1394 ports on the back of your TV to connect digital video devices that meet CEA specifications for IEEE-1394.

Because these ports are bi-directional, they can be used for both playback and recording.

- Because IEEE-1394 is an evolving technology, it is possible that some or all of the connectivity features of a device you connect to the TV through the IEEE-1394 ports may not operate. You should confirm that the devices you desire to use with the IEEE-1394 ports will operate with those ports.
- This TV does not support all possible IEEE-1394 signal types. For information on signals supported by the IEEE-1394 ports, see "Supported signals" at right.
- IEEE-1394 cable carries both audio and video information; no separate audio cables are required for a complete connection.

### You will need:

- ▶ one (or two) IEEE-1394 cables
  - Note:** The transmission capability of IEEE-1394 cable used with this TV must be S400 (400 Mbps maximum).
- ▶ additional A/V cables if your device is analog-compatible (see "Using analog-compatible IEEE-1394 devices" below).

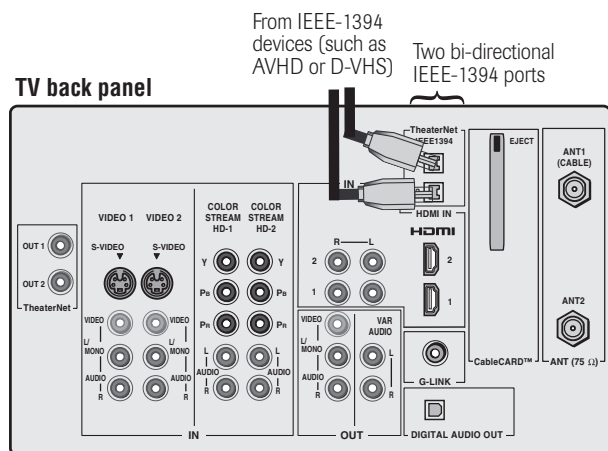

### Using analog-compatible IEEE-1394 devices

Some digital IEEE-1394 devices are compatible with analog signals. For example, some D-VHS VCRs can record and play VHS or S-VHS format videos. Such devices allow you to play analog tapes that you rented or recorded, or record analog programs from antenna or Cable TV systems. To use the IEEE-1394 device's analog features, you need to connect the device to the TV using standard A/V cables (or S-video plus audio cables) in addition to connecting the IEEE-1394 cable.

**Note:** If you have an IEEE-1394 device connected to both digital and analog inputs on the TV, the TV automatically switches between analog and digital modes, as needed, when the initial device access is initiated using the TheaterNet button. See page 44 for details on using the TheaterNet feature.



**NOTE: NEVER CONNECT THIS TV TO A PERSONAL COMPUTER (PC).**  
THIS TV IS NOT INTENDED FOR USE WITH A PC.

### Supported signals

The IEEE-1394 ports support the signals listed below only. Although incompatible video, audio, and digital control signals cannot be decoded by the TV, these signals may be passed through the IEEE-1394 cable to other compatible devices. Incompatible devices may not appear in the TheaterNet™ menu.

#### • MPEG-2 digital video signals

Other digital video signals—such as DV video—are incompatible and must be decoded by the source device and sent to the TV as analog video (composite or S-video).

#### • Dolby Digital and MPEG digital audio signals

Other digital audio signals (such as DPM, MP3, and DTS) are incompatible and cannot be decoded by the TV.

#### • EIA-775 and AV/C digital control

Your TV can serve as the control center for many devices that are compatible with EIA-775 or AV/C IEEE-1394 control standards (described below).

The TV cannot control IEEE-1394 devices that use any other control standards.

- **EIA-775 digital control** allows tuning devices (such as Cable boxes) to send simple graphics; however, this standard does not allow the TV to control the Cable box through IEEE-1394.
- **AV/C (audio/video control)** provides basic control (such as power, play, stop, rewind, fast-forward, pause, and record), as applicable to the specific device.

### Using TheaterNet™ on-screen device control

You can use the TheaterNet feature to control some IEEE-1394 devices using on-screen control icons. See page 44 for details on setting up and using the TheaterNet feature.

**Note:** If the TheaterNet feature does not control your IEEE-1394, you can try using IR pass-through with the TV's remote control (page 21) or use the device's remote control.

## Connecting IEEE-1394 video devices (continued)

### Connecting an A/V HD (external hard drive) or D-VHS digital recorder

You can connect an IEEE-1394 compatible D-VHS or A/V HD digital recorder (such as Toshiba's Symbio™ 160HD4 AVHD) to record high definition and standard definition material from either tuner and control live TV (pause, rewind, fast forward, etc.).

*Toshiba's Symbio 160HD4 AVHD (audio/video hard drive) is a recorder designed specifically for high definition television (HDTV). The Symbio AVHD offers control over digital video recording and playback. Think of it as a "tapeless" VCR for digital television. You can pause, fast forward, reverse, or use instant replay, so you'll never miss a thing. However, unlike a traditional VCR, where you wait for a program to finish recording before you start watching it, the Symbio AVHD allows you to "pause live TV." For example, you can pause, rewind, and play back a program while it is being recorded. Since there is no tape to rewind, you can view a program that started recording 20 minutes ago, even while it is still recording.*

#### When you connect a D-VHS or A/V HD device to the TV:

- The remote control keys (REW, PAUSE, PLAY, FF, etc.) are automatically activated to allow control of live TV.
- The TV Guide On Screen system is automatically configured to allow recording to the device. See Chapters 5 and 7 for details. Also see page 50 for details on setting the A/V HD device skip time.
- Some programs may not be recorded due to copy protection restrictions.



**NOTE: NEVER CONNECT THIS TV TO A PERSONAL COMPUTER (PC).**  
THIS TV IS NOT INTENDED FOR USE WITH A PC.

The unauthorized recording, use, distribution, or revision of television programs, videotapes, DVDs, and other materials is prohibited under the Copyright Laws of the United States and other countries, and may subject you to civil and criminal liability.

### IEEE-1394 device initialization

When you connect a new IEEE-1394 device to the TV and turn it on, the device immediately announces its presence to the TV (and other networked IEEE-1394 devices, if any), and the following device initialization screen automatically appears.



**Note:** With some devices, it may take up to one minute for this screen to appear.

1. If you have connected your IEEE-1394 device to an analog input also, use the ▲▼◀▶ buttons to select the input in the ANALOG INPUT USED field; otherwise, leave it set to "None." (See "Using analog-compatible IEEE-1394 devices" on page 22.)
2. If you want to label the device, highlight EDIT LABEL and press ENTER.



3. Press the ▲▼◀▶ buttons to select a character for the first space and then press ENTER.
4. Repeat step 3 to enter the rest of the characters.
5. Highlight SAVE and press ENTER to save the information.

#### Note:

- The TV may not recognize non-A/V or non-compatible IEEE-1394 devices; however, these devices may still be available to other compatible IEEE-1394 devices on the network.
- You may be able to use the TV's remote control to operate some compatible IEEE-1394 devices. You must first program the remote control to recognize the device (see Chapter 3). If you have an IEEE-1394 Cable box or satellite receiver, you may need to use the remote control that came with the device.

## Connecting IEEE-1394 video devices (continued)

### IEEE-1394 device management

The IEEE-1394 device information is saved in the TV's memory. You can edit this device information (for example, to edit the device name, change the analog input information, or delete the device information from the TV's memory if you no longer use that device).

#### To edit the IEEE-1394 device information:

1. Press MENU and open the SETUP menu.
2. Highlight INSTALLATION and press ENTER. (A new set of INSTALLATION menu icons will appear on-screen, as shown in step 3 below).

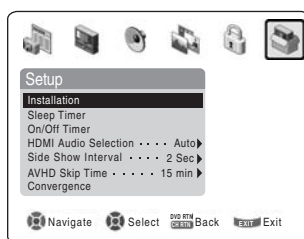

3. Open the DEVICES menu, highlight IEEE-1394 DEVICES, and press ENTER.



4. Highlight the device you want to edit and press ENTER.



5. Follow the on-screen prompts to modify the device information.

### Important information regarding IEEE-1394 device interconnection

#### Note:

- **Do not loop the last device in the chain back to the TV.** If the device chain is looped, the TV may not work properly with the other devices in the chain.
- **Place devices with the slowest communication speed at the end of each chain.** If a device with a slower communication speed is placed ahead of a faster device in the chain, the signal from the slower device will interfere with the signal from the faster device. To determine the communication speed of an IEEE-1394 device, look for an "S" number near the device's IEEE-1394 connector. The higher the "S" number, the faster the device. If your device is not marked with an "S" number, look in the device's user manual or call the device manufacturer's technical support number.
- **If your IEEE-1394 device has a two-position power switch, place the device at the end of the chain or leave the power switch ON at all times.** If the power switch is OFF, it will interfere with signals from devices behind it in the chain.
- **The maximum length for an IEEE-1394 cable between each device is 15 feet.**
- This TV is an IEEE-1394A device. The IEEE-1394B protocol is faster and intended to allow for longer distances between devices and multi-room systems. IEEE-1394A-to-IEEE-1394B converters (available at some electronics suppliers) may allow compatibility of IEEE-1394B devices with your existing IEEE-1394A devices.
- The transmission capability of IEEE-1394 cable used with this TV must be S400 (400 Mbps maximum).



## G-LINK™ connection

**This connection is necessary for the TV Guide On Screen™ system to work with your cable box to receive program listings and to enable TV Guide On Screen recording features with your VCR.**

**Note:** This connection is not necessary for A/V HD or D-VHS recording devices. See pages 23 and 50 for further details.

After you connect your devices to the TV, you will need to connect the G-LINK cable (either of the dual-wand IR blaster cables included with your TV) from your VCR and Cable box (if applicable) to the G-LINK jack on the TV.

**Note:** TV Guide On Screen program data is available through the ANT-1 and ANT-2 antenna inputs and also through the VIDEO 1 inputs **if** you have a cable box connected to VIDEO 1. TV Guide On Screen program data is not available through any other inputs on this TV. See the connection information on pages 13–18.

The G-LINK connection is necessary to enable the following features of your TV Guide On Screen™ system:

- If you have a Cable box, you need to connect the G-LINK cable from the Cable box to the G-LINK jack to receive the TV Guide On Screen system's program listings for your Cable service.
- If you have a VCR, you need to connect the G-LINK cable from the VCR to the G-LINK jack to use the TV Guide On Screen system's recording features.

### To connect to the G-LINK jack:

1. Locate the infrared sensor on the front of your VCR or Cable box. The sensor is marked on some devices.\*
2. Align one of the G-LINK (IR blaster) cable's wands about 1 inch away from the infrared sensor on the front of the VCR and attach it using double-sided mounting tape. If you have a Cable box, attach the other wand in a similar manner. (See illustration at right.)  
**Note:** If you do not have a Cable box, coil the second wand with a rubber band and leave it behind the TV.
3. Plug the G-LINK (IR blaster) cable's plug into the TV's G-LINK jack.

### For details on setting up the TV Guide On Screen system:

See Chapter 5.

### For details on using the TV Guide On Screen interactive program guide:

See Chapter 7.

#### \*If you cannot locate the device's infrared sensor:

1. Turn OFF the device.
2. Starting at the lower left corner of the device, place the end of the device's remote control (with the infrared emitter) so it touches the front of the device and press POWER. (Do not use the TV's remote control for this step.)
3. If the device turns on, the place the remote control touched the device is the location of the sensor.
4. If the device does not turn on, move the remote control slightly to the right and press POWER again.
5. Repeat step 4 until you locate the device's infrared sensor.

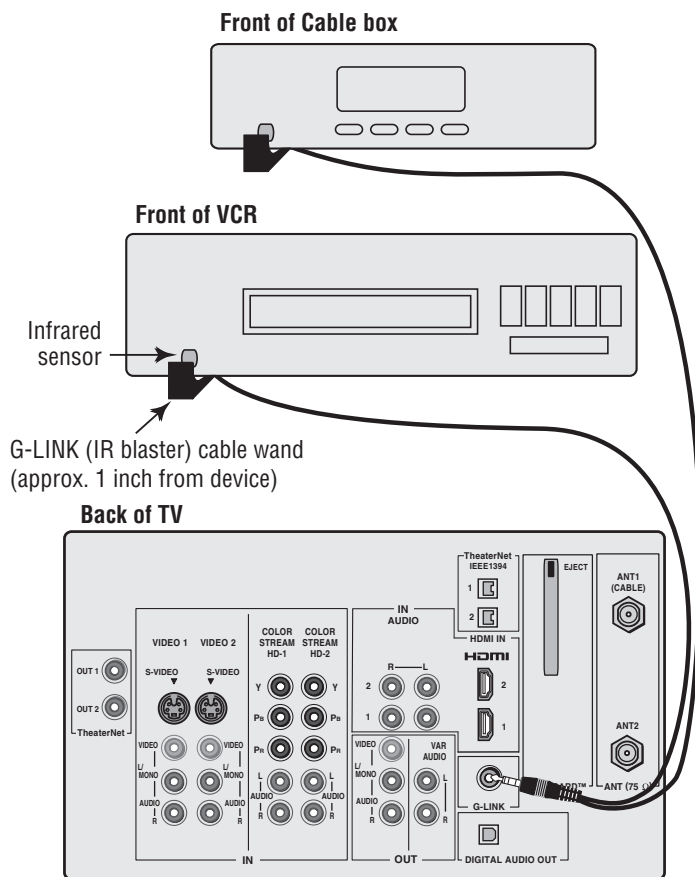

### 3 Using the remote control

#### Learning about the remote control

The buttons used for operating the TV only are described here. For a complete list of the remote control's functions, see the remote control functional key chart on pages 28–29.

**POWER** turns the TV on and off.

**SLEEP** accesses the sleep timer (page 87).

**LIGHT** The first press of the LIGHT button lights the keypad and turns on the Illumination mode. With the Illumination mode on, pressing any other key lights the keypad for 5 seconds (10 seconds if you're in programming mode). Subsequent presses of the LIGHT button toggle between turning the Illumination mode on and off.

**Channel Numbers (0–9, –/100)** directly tune channels. The “–” button is used to tune digital channels (page 69).

**INPUT** selects the video input source (page 67).

**MODE** cycles through the six device modes: TV, CBL/SAT, VCR/PVR, DVD, AUDIO1, and AUDIO2. The mode indicator light will remain lit for a few seconds (page 27).

**PIC SIZE** cycles through the five pictures sizes: Natural, TheaterWide 1/2/3, and Full (page 70).

**TheaterNet DEVICE** displays a list of available TheaterNet devices (page 44).

**TheaterNet CTRL** accesses the on-screen IR device control icons (page 44).

**MENU** accesses the menu system (pages 34 and 35).

**TV GUIDE** opens the TV Guide On Screen system (Chapter 7).

**INFO** provides detailed information on highlighted items in the TV Guide On Screen system (Chapter 7).

**ENTER** activates highlighted items in the main menu system and the TV Guide On Screen system.

Arrow buttons (▲▼◀▶) select or adjust programming menus.

**CH ▲▼** cycles through programmed channels when no menu is on-screen (41); functions as page up/down when a menu is on-screen or when the TV Guide On Screen system is open (Chapter 7).

**VOL ▲▼** adjusts the volume level.

**EXIT** closes on-screen menus and the TV Guide On Screen system.

**CH RTN** returns to the last viewed channel (page 69), or stops the picture viewer slide show (page 85).

**Live** returns viewing of the TV back to the live program, while continuing to record to the Toshiba Symbio™ AVHD (page 23).

**RECALL** displays TV setting information on-screen (page 87).

**MUTE** reduces or turns off the sound (page 81).

**TV/VCR** selects TV mode to view one program while recording another.

**SKIP/SEARCH ▶▶** and **◀◀** jump forward and backward one day in the TV Guide On Screen listings (Chapter 7).

**LIST** displays the Toshiba Symbio™ AVHD play list (if available) (page 23).

**FAV CH ▲▼** tunes to the next higher/lower favorite channel (page 43).

**VCR+** accesses the TV Guide On Screen manual recording function.

**SPLIT** turns the POP feature on and off (page 74).

**PIC MODE** selects the picture mode (page 77).

**FAV SCAN** accesses the favorite channel search function (page 76).

**FREEZE** freezes the main picture in the double-window (page 75).

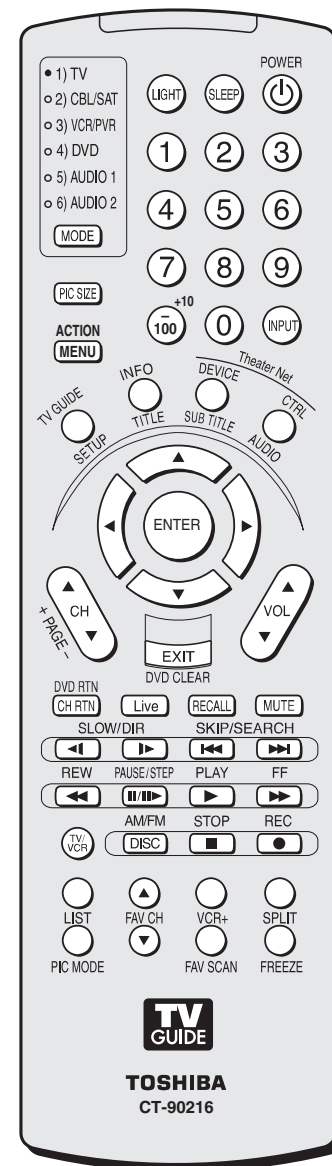

**Note:**

The error message “Not Available” will appear if you press a key for a function that is not available.

## Installing the remote control batteries

### To install the remote control batteries:

**CAUTION:** Always dispose of batteries in a designated disposal location. Never throw batteries into a fire.

- Slide the battery cover off the back of the remote control.

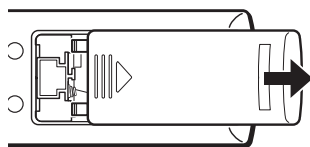

- Install two “AA” size alkaline batteries. Match the + and – symbols on the batteries to the symbols on the battery compartment.

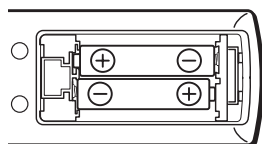

- Slide the battery cover on to the remote control until the lock snaps.

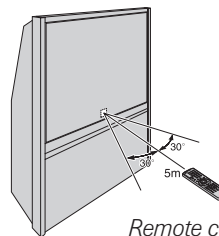

Remote control effective range

### Note:

- Batteries should always be disposed of with the environment in mind. Always dispose of batteries in accordance with applicable laws and regulations.
- Never mix battery types or use new and used batteries in combination.
- When necessary to replace batteries in the remote control, always replace both batteries with new ones.
- Always remove batteries from remote control if they are dead or if the remote control is not to be used for an extended period of time. This will prevent battery acid from leaking into the battery compartment.

## Using the remote control MODE button to control your other devices

Your TV remote control has one dedicated TV mode and five programmable multi-brand modes: CBL/SAT, VCR/PVR, DVD, AUDIO 1, and AUDIO 2. The default device modes and programmable device modes are listed below.

**Note:** The TV remote control is preprogrammed to operate most Toshiba devices. If you own a non-Toshiba device or a Toshiba device that the remote control is not preprogrammed to operate, you will need to program the remote control. See “Programming the remote control to operate your other devices” on page 30.

MODE	Default device mode control (before programming)
1) TV	Toshiba TV
2) CBL/SAT	Toshiba Satellite receiver
3) VCR/PVR	Toshiba VCR
4) DVD	Toshiba DVD
5) AUDIO 1	Pioneer Audio receiver
6) AUDIO 2	Pioneer LD

MODE	Device mode control after programming
1) TV	Toshiba TV
2) CBL/SAT	Multi-brand video/audio devices
3) VCR/PVR	
4) DVD	
5) AUDIO 1	
6) AUDIO 2	

You can directly select the device mode by pressing the corresponding number button (1-6) while pressing the MODE button.

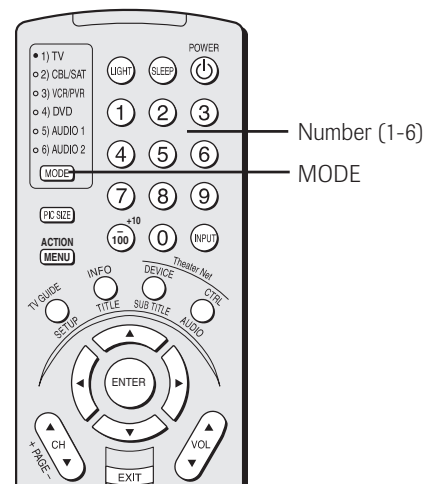

### Note:

Although your new TV's remote control includes codes for many devices, it may not include codes for some or all of the features on certain devices you wish to control. If you are unable to program the TV's remote control to operate your device or some of the features on that device, use the device's remote control or the controls on the device.

## Remote Control functional key chart

Key Label	Toshiba TV (TV)	Cable (CBL/SAT)	Satellite (CBL/SAT)	VCR	DVD/LD	Receiver (AUDIO)	CD (AUDIO)	PVR (VCR)
MODE	Remote control device mode selection							
LIGHT	Lights the remote key, and toggles between enabled and disabled Illumination mode.*1							
SLEEP	Sleep timer	---	---	---	---	---	---	---
POWER	Power	Power	Power	Power	Power	Power	Power	Power
1	Digit 1	Digit 1	Digit 1	Digit 1	Digit 1	AV input 1	Digit 1	Digit 1
2	Digit 2	Digit 2	Digit 2	Digit 2	Digit 2	AV input 2	Digit 2	Digit 2
3	Digit 3	Digit 3	Digit 3	Digit 3	Digit 3	AV input 3	Digit 3	Digit 3
4	Digit 4	Digit 4	Digit 4	Digit 4	Digit 4	AV input 4	Digit 4	Digit 4
5	Digit 5	Digit 5	Digit 5	Digit 5	Digit 5	CD	Digit 5	Digit 5
6	Digit 6	Digit 6	Digit 6	Digit 6	Digit 6	Tuner	Digit 6	Digit 6
7	Digit 7	Digit 7	Digit 7	Digit 7	Digit 7	Phono	Digit 7	Digit 7
8	Digit 8	Digit 8	Digit 8	Digit 8	Digit 8	Cassette	Digit 8	Digit 8
9	Digit 9	Digit 9	Digit 9	Digit 9	Digit 9	Aux	Digit 9	Digit 9
0	Digit 0	Digit 0	Digit 0	Digit 0	Digit 0	---	Digit 0, 10	Digit 0
100/-	- (digital separator)	---	- (sub channel)	100	+10	---	---	---
INPUT	TV/Video select	← TV	← TV	VCR input	← TV	---	← TV	← TV
PIC SIZE	Selects the image shape.	← TV	← TV	← TV	← TV	← TV	← TV	← TV
MENU/ACTION	Menu/ Guide Menu	---	Action, Menu	---	Menu	---	---	Menu
TV GUIDE/SETUP	TV Guide	---	Guide	---	DVD setup	---	---	Guide
INFO/TITLE	Guide Info	---	INFO	---	TITLE= Top menu	---	---	INFO
TheaterNet DEVICE/SUBTITLE	Theater Net Device	---	---	---	Subtitle	---	---	ADVANCE
TheaterNet CTRL/AUDIO	Theater Net Control	---	---	---	Audio	---	---	---
ENTER	Enter	---	Enter, Select	---	Enter	---	---	Enter
▲	Menu select up	---	Menu select up	---	Menu select up	---	---	Menu select up
▼	Menu select down	---	Menu select down	---	Menu select down	---	---	Menu select down
◀▶	Menu select left/right	---	Menu select left/right	---	Menu select left/right	---	---	Menu select left/right
EXIT/DVD CLEAR	Exit	---	Exit	---	DVD clear	---	---	---
CH ▲▼ PAGE +/-	Channel up/down, Page up/down	Channel up/down	Channel up/down	Channel up/down	---	Channel up/down	---	Channel up/down
VOL ▲▼	Volume up/down*2	Volume up/down*2	Volume up/down*2	Volume up/down*2	Volume up/down*2	Volume up/down*2	Volume up/down*2	Volume up/down*2
CH RTN/DVD RTN	Previous channel	Previous channel	Previous channel	---	DVD return	---	---	---
Live	Live	---	---	---	---	---	---	Live TV
RECALL	On-screen display	---	---	On-screen display	On-screen display	---	---	---



## Remote Control functional key chart (continued)

Key Label	Toshiba TV (TV)	Cable (CBL/SAT)	Satellite (CBL/SAT)	VCR	DVD/LD	Receiver (AUDIO)	CD (AUDIO)	PVR (VCR)
MUTE	Sound mute*2	Sound mute*2	Sound mute*2	Sound mute*2	Sound mute*2	Sound mute*2	Sound mute*2	Sound mute*2
SLOW/DIR	---	---	---	Slow FWD	Slow FWD Slow REW	---	---	Slow FWD ---
SKIP/SEARCH	Skip FWD Skip REW	---	---	---	Skip FWD Skip REW	---	Skip FWD Skip REW	---
REW	Rewind	---	---	Rewind	Rewind	---	Rewind	Rewind
PAUSE/STEP	Pause	---	---	Pause	Pause	---	Pause	Pause
PLAY	Play	---	---	Play	Play	---	Play	Play
FF	Fast FWD	---	---	Fast FWD	Fast FWD	---	Fast FWD	Fast FWD
TV/VCR	---	---	TV/SAT	TV/VCR	---	---	---	Reverse
DISC/AM/FM	---	---	---	---	Disc shift	AM/FM	Disc shift	Replay
STOP	Stop	---	---	Stop	Stop	---	Stop	Stop
REC	REC Menu (Single Click)	---	---	Record (Double Click)	---	---	---	Record (Double Click)
LIST	LIST	---	---	---	---	---	---	---
FAV CH ▲▼	FAV channel up/down	---	---	---	---	---	---	---
VCR+	VCR+	---	---	---	---	---	---	---
SPLIT	Split	← TV	← TV	← TV	← TV	← TV	← TV	← TV
PIC MODE	PIC MODE	← TV	← TV	← TV	← TV	← TV	← TV	← TV
FAV SCAN	FAV SCAN	---	---	---	---	---	---	---
FREEZE	Freeze	← TV	← TV	← TV	← TV	← TV	← TV	← TV

**Notes:**

- “---” will send nothing.
- “← TV” will jump to TV.
- “→ VCR” will jump to last active VCR or DVD. (“Last active VCR/DVD” is the mode that remains for a minimum of 5 seconds, or if a key is pressed in that mode.)

\*1 Backlight key is toggle. Does not send IR signal.

\*2 Volume will punch through to TV by default. When the volume is unlocked, all the devices will have their own volume if their ID has volume data. The AUD modes (receiver, CD) will have their own volume if volume lock is done to TV, CBL/SAT, VCR/PVR, or DVD mode. See “Using the volume lock feature” on page 31.

## Programming the remote control to operate your other devices

### Device code setup

1. Refer to the multi-brand remote control device code table on pages 32–33 to find the code for the brand of your device.  
If more than one code is listed, try each one separately until you find the one that works.
2. Press MODE until the Mode indicator for the device (CBL/SAT, VCR/PVR, DVD, AUDIO 1, AUDIO 2) lights up.
3. While holding down the RECALL button, press the Channel Number buttons to enter the four-digit code for your brand of device. If a valid code is entered, the mode indicator will blink twice. If an invalid code is entered, the mode indicator will blink one long blink.
4. Point the remote control at the device and press POWER to test the code.

*If the device responds to the remote control:*

You have entered the correct code.

*If the device does not respond to the remote control:*

You may have entered the wrong code. Repeat steps 3 and 4 using another code.

**Note:** In addition to POWER, confirm that all necessary keys on the TV remote control operate your device. If some keys are not operational, repeat the device code setup using another code (if other codes are listed for your device). If, after trying all listed codes, the necessary keys do not operate your device, use the device's original remote control.

5. Press MODE to select the TV mode to control the TV.

#### Note:

- Although the TV remote control includes codes for many devices, it may not include codes for some or all of the features on certain devices you wish to control. If you are unable to program the TV remote control to operate your device or some of the features on that device, use the device's remote control or the controls on the device.
- Each time you change the batteries you will need to reprogram the remote control.
- Some newer VCRs respond to either of two codes. These VCRs have a switch labeled "VCR1/VCR2." If your VCR has this kind of switch and does not respond to the codes for your VCR brand, set the switch to the other position ("VCR1" or "VCR2") and reprogram the remote control.

### Searching and sampling the code of a device (8500)

If you do not know the device code for a particular device, you can cycle the remote control through the available codes for that device mode and sample the functions to find the code that operates the target device. The keys available to be sampled, provided they are applicable to that mode, are POWER, 1, VOL ▲, CH ▲, and PLAY. Invalid keys will be ignored while in program mode.

#### To cycle through each available device code and sample its functions:

1. Press MODE to select the mode you want to set up.
2. While holding down RECALL, press 8 – 5 – 0 – 0. The remote control will enter program mode.
3. Point the remote control at the target device and press POWER (or other function buttons that are available to be sampled).

4. *If the device responds to the remote control:*

Press RECALL to store the device code. The mode indicator will blink twice and the remote control will exit the program mode.

*If the device does not respond to the remote control:*

Press ▲, and then press POWER.

Repeat this step until the device responds to the remote control, and then press RECALL.

**Note:** When a search cycle is completed, the mode indicator will blink three times. The remote control will begin to cycle through the available codes again. If no key is pressed within 10 seconds while programming, the remote control will exit the program mode and return to the previous code.

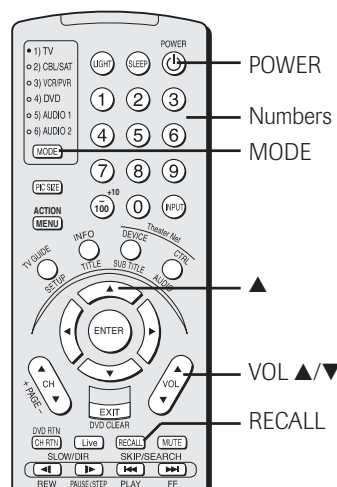

## Programming the remote control to operate your other devices (continued)

### Using the volume lock feature (8000)

For the TV, CABLE/SAT, VCR, and DVD modes, the volume controls (VOL ▲/▼ and MUTE) can be locked to the selected device mode. This feature does not apply to the AUDIO 1 and AUDIO 2 modes.

#### To lock the volume controls to always control the CABLE/SAT device volume (for example):

1. Repeatedly press MODE to select CABLE/SAT mode.
2. While holding down the RECALL button, press 8 – 0 – 0 – 0.
3. Press VOL ▲.

The CABLE/SAT mode light will blink two times (locked).

#### To reset the volume controls to the original device mode:

1. While holding down RECALL, press 8 – 0 – 0 – 0.
2. Press VOL ▼.

The mode light will blink four times (unlocked).

### Operational feature reset (8900)

This feature clears all setup features not related to “Device code set up” and resets the Volume Lock to “TV.”

To reset the features:

While holding down the RECALL button, press 8 – 9 – 0 – 0.  
The Mode indicator will blink two times, and then pause and blink two more times.

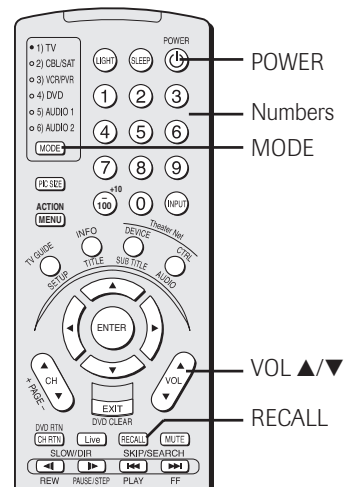

## Multi-brand remote control device codes

VCRs/PVRs		VCRs/PVRs (cont.)		Cable boxes	
Brand	Code	Brand	Code	Brand	Code
ADMIRAL	0135	PHILCO	0100, 0111, 0145	ABC	1124
AIWA	0127, 0132, 0181 0129, 0114, 0115, 0116	PHILIPS	0131, 0124, 0127, 0123, 0126, 0120, 0143	ARCHER	1132, 1125
AKAI	0139, 0111	PIONEER	0131, 0123, 0124, 0173	CABLEVIEW	1105, 1132
AUDIO DYNAMIC	0105, 0113	PROSCAN	0123 0145, 0100, 0123, 0124, 0131, 0146, 0101, 0102, 0133, 0174	CITIZEN	1122, 1105
BELL&HOWELL	0120, 0126, 0180	QUASAR	0121, 0122, 0123, 0124	CURTIS	1112, 1113
BROKSONIC	0123, 0125	RADIO SHACK	0133, 0124, 0105, 0136, 0109, 0140, 0127	DIAMOND	1124, 1132, 1125
CANON	0143	RCA	0127 0133, 0145, 0100, 0123, 0124, 0131, 0146, 0101, 0102, 0170, 0172, 0174, 0176, 0183	EAGLE	1129
CCE	0106	Replay TV	7102	EASTERN	1134
CITIZEN	0105, 0129, 0106	REALISTIC	0124, 0105, 0136, 0109, 0140, 0127	GCBRAND	1132, 1105
CRAIG	0145, 0124, 0127	SAMSUNG	0137, 0102, 0104, 0133	GEMINI	1122, 1143
CURTIS MATHES	0143, 0101, 0124, 0175	SAMTRON	0163	G.I./JERROLD	1119, 1124, 1125, 1126, 1127, 1120, 1121, 1122, 1111, 1123, 1152
DAEWOO	0139, 0110, 0111	SANSUI	0139, 0126, 0120, 0152	HAMLIN	1140, 1141, 1142,
DBX	0145	SANYO	0105, 0109, 0113	HITACHI	1145, 1118, 1112
DIMENSIA	0143, 0126, 0119, 0103, 0125, 0142, 0120, 0118	SCOTT	0101, 0102, 0104, 0109, 0138, 0140, 0147, 0148, 0126, 0120	MACOM	1103, 1124
EMERSON	0105, 0108, 0109, 0107, 0113, 0165	SEARS	0105, 0106, 0107, 0108, 0100	MAGNAVOX	1103, 1104, 1105, 1108
FISHER	0127, 0126, 0120,	SHARP	0135, 0136, 0167, 0162	MEMOREX	1133
FUNAI	0134	SHINTOM	0117	MOTOROLA	1119, 1124, 1125, 1126, 1127, 1120, 1121, 1122, 1111, 1123, 1152
GE	0133, 0145, 0124	SIGNATURE 2000	0127, 0135	MOVIE TIME	1109, 1110, 1114,
GO VIDEO	0137, 0151, 0163, 0149, 0150, 0182	SINGER	0117	OAK	1151, 1153
GOLDSTAR	0106	SONY	0128, 0129, 0130, 0153, 0154, 0155, 7101	PANASONIC	1128, 1129, 1130,
GRADIENTE	0170, 0171, 0168, 0134, 0156	SV2000	0127	PHILIPS	1106, 1107, 1150, 1131
HITACHI	0123, 0145, 0100, 0127, 00168	SYLVANIA	0131, 0123, 0124, 0127, 0178	PIONEER	1101, 1116
INSTANT REPLAY	0124, 0123	SYMPHONIC	0127, 0168, 0177	REMBRANT	1105, 1132
JENSEN	0139	TASHIRO	0106	SAMSUNG	1111, 1112, 1113 1105, 1101
JVC	0139, 0110, 0111, 0134, 0157, 0158, 0184, 0185, 7104	TATUNG	0139, 0110, 0111	S.A.	1105, 1110
KENWOOD	0139, 0110, 0106, 0111, 7104	TEAC	0139, 0110, 0127, 0111	SLMARK	1132, 1105
LG	0159	TECHNICS	0121, 0122, 0123, 0124	SPRUCER	1148
LXI	0127, 0106, 0100, 0107, 0108, 0105, 0109	TEKNIKA	0124, 0127, 0112	STARGATE	1101, 1105
MAGNAVOX	0131, 0123, 0124, 0173	THOMSON	0179, 0183	TELECAPTION	1144
MARANTZ	0139, 0110, 0111	Tivo	7100, 7101	TELEVIEW	1135, 1136, 1147
MARTA	0106	TOSHIBA	0101, 0146, 0166, 0160	TEXSCAN	1104, 1146
MEMOREX	0124, 0109	VECTOR RESEARCH	0111	TOCOM	1132, 1125
MGA	0138, 0140, 0147, 0148, 0141, 0142	WARDS	0135, 0136, 0109, 0144, 0106	TOSHIBA	1122, 1132
MINOLTA	0100, 0145	YAMAHA	0105, 0139, 0110, 0111	UNIKA	1106
MITSUBISHI	0138, 0140, 0147, 0148, 0141, 0142, 0161, 0164	ZENITH	0144, 0106, 0169, 0180	UNIVERSAL	1129, 1130
MULTITECH	0147, 0127, 0104			VIDEOWAY	1117, 1100
NEC	0139, 0110, 0111, 0134			VIEWSTAR	1100
OLYMPIC	0124, 0123			ZENITH	
OPTIMUS	0128, 0121, 0135, 0106			ZENITH/DRAKE	
ORION	0126, 0120, 0132			SATELLITE	
PANASONIC	0123, 0124, 0121, 0122, 7100				
PENNEY	0124, 0100, 0145,				
PENTAX	0105, 0139, 0110, 0111				



## Multi-brand remote control device codes (continued)

## CD players

Brand	Code
ADMIRAL	6126
AIWA	6133, 6135
CARVER	6129
DENON	6142, 6151
EMERSON	6139
FISHER	6105, 6106
GARRARD	6117
HARMAN KARDON	6120, 6121, 6123, 6119
HITACHI	6107
JENSEN	6134
JVC	6140, 6141, 6145, 6148, 6151
KARDON	6123
KENWOOD	6100, 6101, 6111, 6145
LXI	6136
MAGNAVOX	6129, 6132
MARANTZ	6129
MCNTOSH	6121
NAKAMICHI	6110
ONKYO	6114, 6115
OPTIMUS	6108, 6118, 6120, 6122
PANASONIC	6124, 6125, 6127, 6150
PHILIPS	6129, 6130, 6149
PIONEER	6108
QUASAR	6125, 6127, 6124
RCA	6147, 6137, 6138, 6131, 6152
SANSUI	6110, 6146, 6113
SANYO	6105
SCOTT	6110, 6146
SHARP	6142, 6143
SHERWOOD	6120
SONY	6128
SOUNDE-SIGH	6144
TEAC	6112, 6116, 6118
TECHNICS	6127, 6124, 6125
VICTOR	6140, 6141, 6145
YAMAHA	6102, 6103, 6104

## Receivers

Brand	Code
ADMIRAL	4120
AIWA	4125, 4126, 4146
DENON	4134, 4135, 4136, 4143
FISHER	4104
GARRARD	4113
HARMAN KARDON	4115, 4123, 4145
JENSEN	4129
JVC	4132, 4133, 4140, 4144
KENWOOD	4100, 4108, 4141, 4142, 4147
MAGNAVOX	4127, 4128
MARANTZ	4124
MCNTOSH	4116
MITSUBISHI	4148
NAKAMICHI	4106, 4117
ONKYO	4109, 4114
OPTIMUS	4103, 4127, 4131, 4130

## Receivers (cont.)

Brand	Code
PANASONIC	4119, 4118, 4121
PHILIPS	4123
PIONEER	4105, 4107, 4150
QUASAR	4119, 4118, 4121
RCA	4103, 4105, 4127, 4131, 4130, 4149
SANSUI	4103, 4111, 4139
SHARP	4134, 4137
SONY	4122
SOUNDE-SIGH	4138
TEAC	4112, 4113, 4111, 4110
TECHNICS	4121, 4118, 4119
VICTOR	4132, 4133
YAMAHA	4101, 4102

## Laser disks

Brand	Code
DENON	5114
HITACHI	5100
KENWOOD	5102, 5103
MAGNAVOX	5101
MARANTZ	5114
MITSUBISHI	5114, 5118, 5119
NEC	5114
PANASONIC	5104, 5105, 5106, 5115
PHILIPS	5111
PIONEER	5114
PROSCAN	5114
QUASAR	5104, 5105, 5106, 5115
RCA	5114
SAMSUNG	5112
SANYO	5114, 5117
SHARP	5113, 5116
SONY	5107, 5108, 5109, 5110
TEAC	5114
TOSHIBA	5114
YAMAHA	5101

## DVD players

Brand	Code
AIWA	3123
APEX	3120
DENON	3100, 3117
FERGUSON	3101
HITACHI	3111
JVC	3109
KENWOOD	3115, 3129
KONKA	3119
MITSUBISHI	3105
NORDMENDE	3101
ONKYO	3121
ORITRON	3124
PANASONIC	3100
PHILIPS	3103, 3116
PIONEER	3102
RAITE	3113
RCA	3101, 3106
SABA	3101
SAMPO	3114
SAMSUNG	3110
SHARP	3108
SILVANIA	3132, 3118
SMC	3125
SONY	3104, 3126, 3127, 3128
TECHNICS	3100
THOMSON	3101
TOSHIBA	3103
WAVE	3122
YAMAHA	3100, 3130
ZENITH	3107, 3112
VIALTA	3131
FUNAI	3132, 3118

## Satellite receivers

Brand	Code
DISH	2105, 2115, 2116,
NETWORK(Echostar)	2117
ECHOSTAR	2105
EXPRESS VU	2105, 2115
G.E.	2106
G.I.(GENERAL INSTRUMENT)	2108
GRADIENTE	2114
HITACHI	2103, 2111, 2112
HNS(Hughes)	2103
MAGNAVOX	2101, 2102
PANASONIC	2104
PHILIPS	2101, 2102, 2118
PRIMESTAR	2108
PROSCAN	2106, 2109, 2110, 2113
RCA	2106, 2109, 2110, 2113
SONY	2107
STAR CHOICE	2103, 2108
TOSHIBA	2100, 2103, 2119, 2120, 2121, 2122, 2123, 2124, 2125
UNIDEN	2101, 2102

# 4 Menu layout and navigation

The illustrations below and on the next page provide a quick overview of your TV's menu system.

## Main menu layout

To open the main menus (illustrated below), press MENU on the remote control or TV front panel.

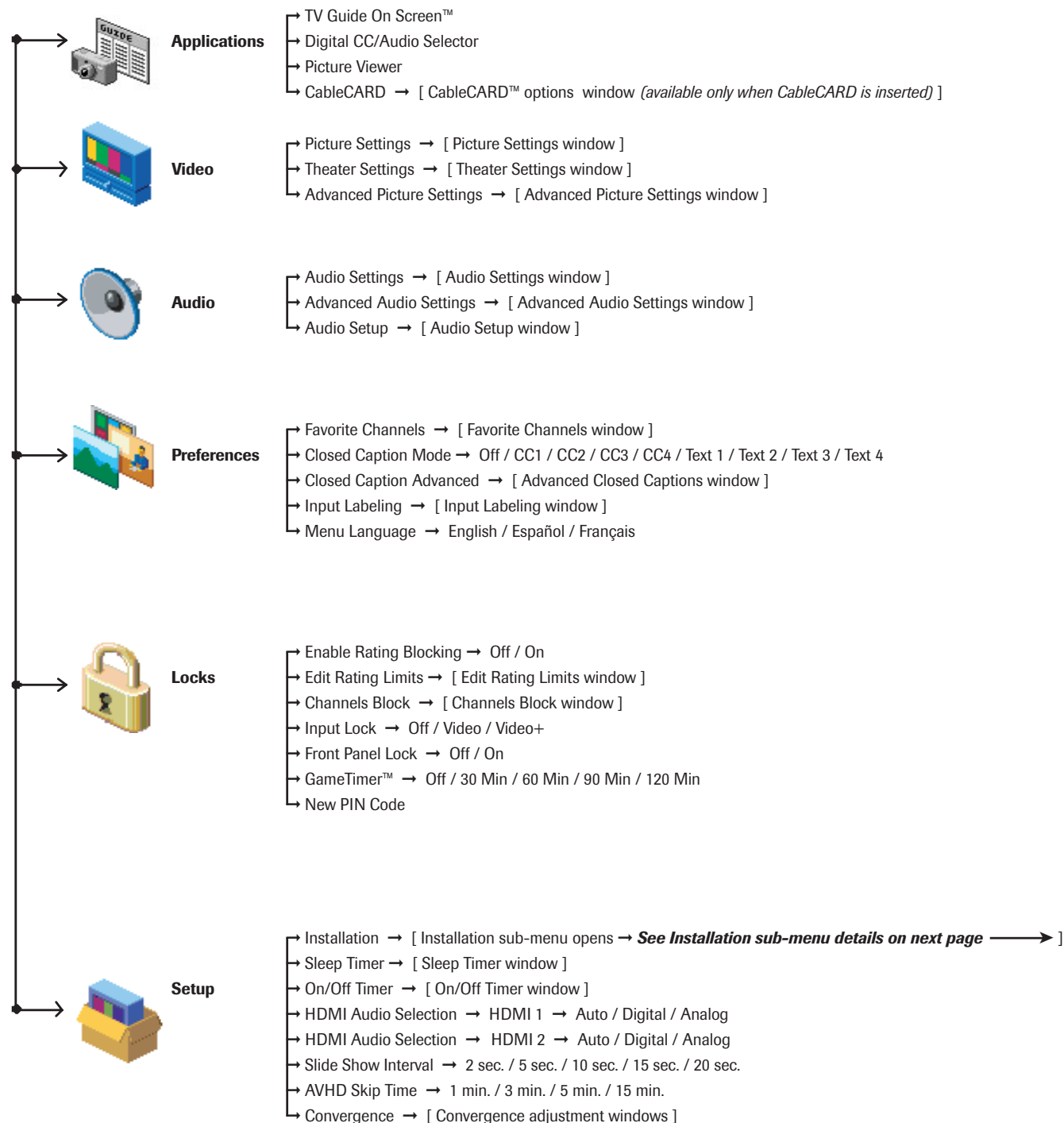

## Setup / Installation menu layout (continued)

To open the INSTALLATION menu (illustrated below): press MENU on the remote control or TV front panel, open the SETUP menu, select INSTALLATION, and press ENTER.

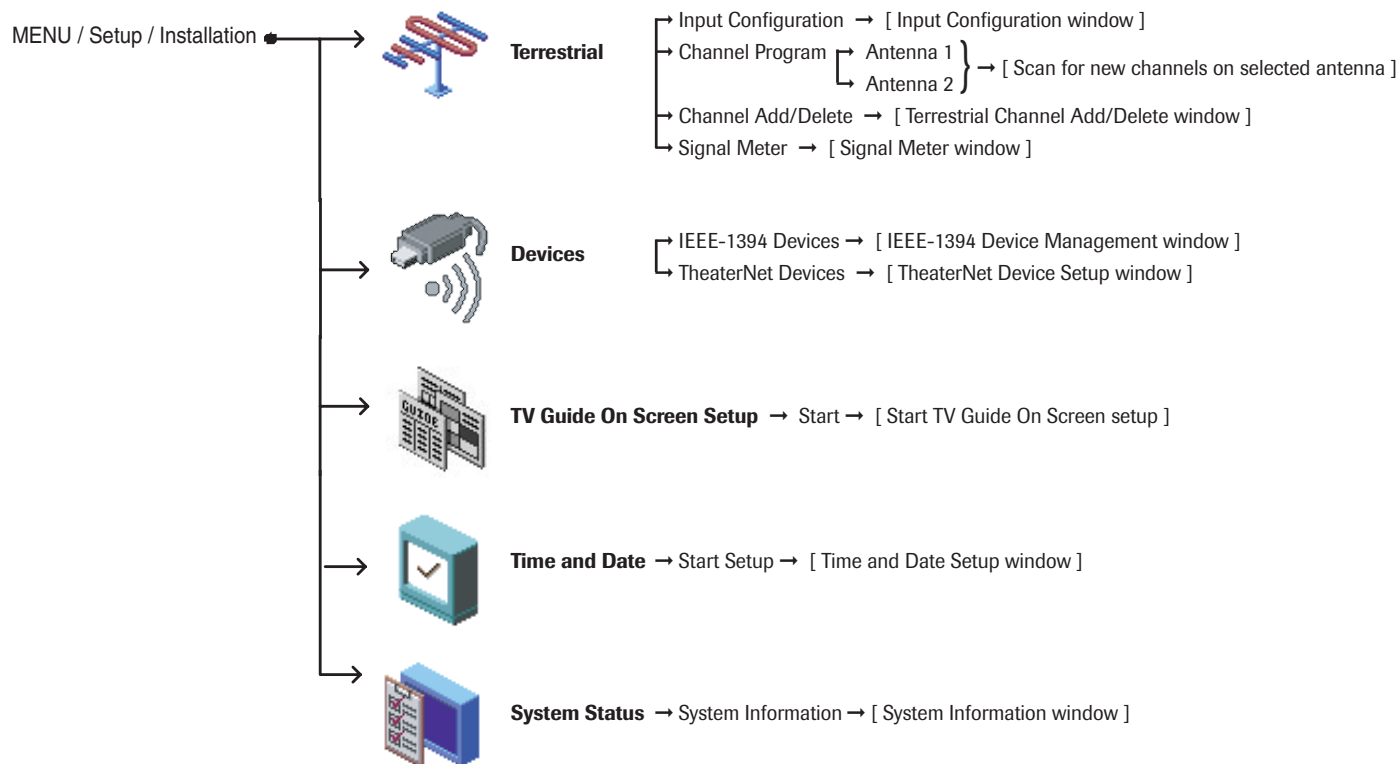

## Navigating the menu system

You can use the buttons on the remote control or TV front panel to access and navigate your TV's on-screen menu system.

- Press MENU to open the menu system.
- Use the up/down/left/right arrow buttons (▲▼◀▶) on the remote control or TV front panel to move in the corresponding direction in a menu.
- Press ENTER to save your menu settings or select a highlighted item. (A highlighted menu item appears in a different color in the menu.)
- All menus close automatically if you do not make a selection within 60 seconds, except the signal meter menu, which closes automatically after 5 minutes.
- To close a menu instantly, press EXIT.

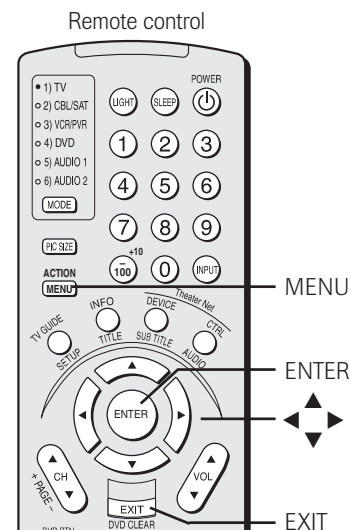
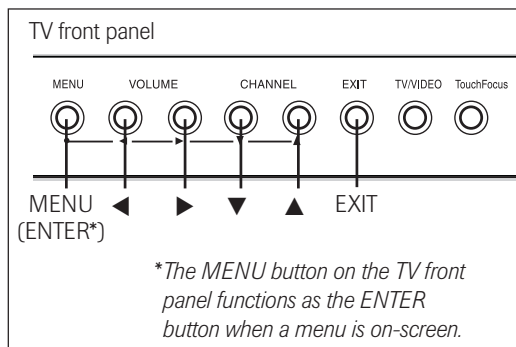

# 5 TV Guide On Screen™ system setup

The TV Guide On Screen™ system in your TV is a free, interactive program guide that uses the information you enter during the following setup process to provide you with a channel lineup and program listings for your area. The listings are automatically updated several times a day.

**Note:** You must first set up your TV according to the applicable connection instructions in Chapter 2.

## To set up the TV Guide On Screen system:

1. Press MENU and open the SETUP menu.
2. Highlight INSTALLATION and press ENTER.

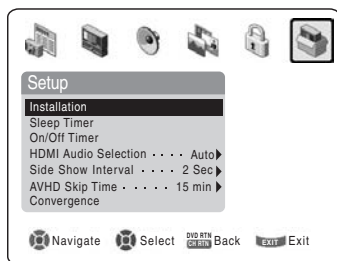

3. A new set of INSTALLATION menu icons appears on-screen (see illustration below). Open the TV GUIDE ON SCREEN SETUP menu, highlight START, and press ENTER.

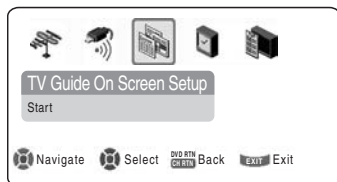

4. The following screen opens. Highlight "Set up TV Guide On Screen now" and press ENTER to continue.

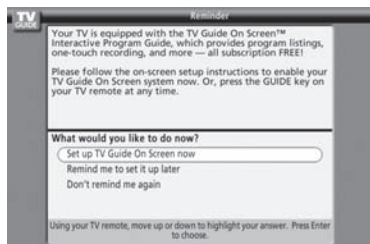

5. The following screen opens. Press ENTER to continue.



## Configuring the location of your TV

**Screen 1:** Select the TV location (USA or Canada), and then press ENTER.

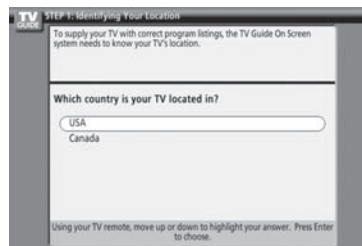

**Screen 2:** Enter the ZIP code (U.S.A.) or postal code (Canada) for your location (use the Number buttons on the remote control for numbers and the ▲▼ buttons for letters), and then press ENTER. Screen 3 appears.

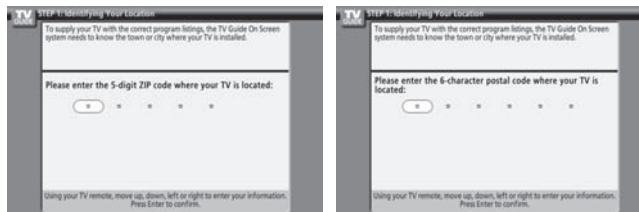

**Screen 3:** Do you have Cable service connected? If you select YES (and press ENTER), screen 4 appears. If you select NO (and press ENTER), screen 12 appears.

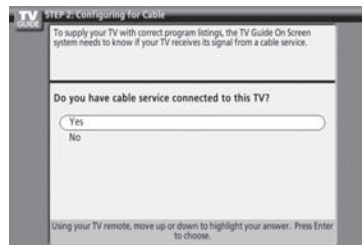

**Screen 4:** Do you have a Cable box connected? If you select YES (and press ENTER), screen 5 appears. If you select NO (and press ENTER), screen 13 appears.

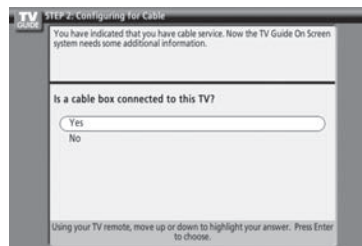



## Setting up the TV Guide On Screen system (continued)

**Screen 5:** Which TV input is your cable box plugged into?  
If you select ANT 1, screen 6 appears.  
If you select VIDEO 1, screen 7 appears.

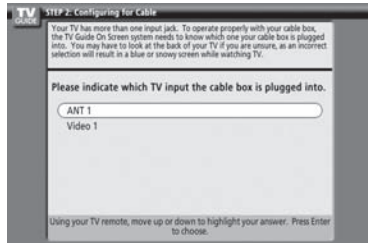

**Screen 6:** Select the channel your TV is tuned to when using your cable box, and then press ENTER. Screen 7 appears.

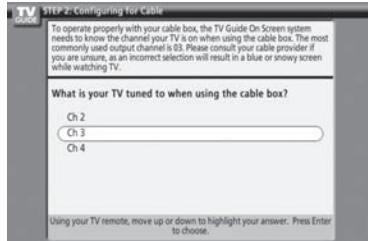

**Screen 7:** The on-screen diagram shows the correct way to connect your Cable box to the G-LINK™ jack on the TV. **Make sure the G-LINK cable is installed properly. For additional details, see page 25.** Press ENTER to display screen 8.

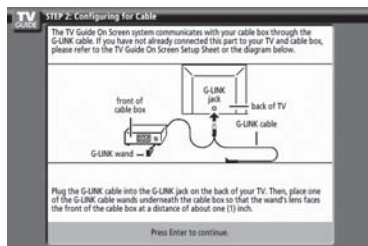

**Screen 8:** Highlight your Cable box brand, and then press ENTER to display screen 9.

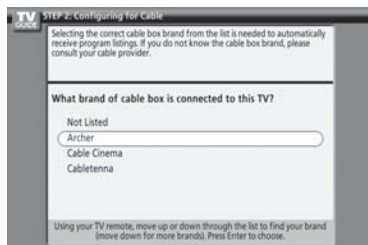

**Screen 9:** To allow the TV Guide On Screen system to find the correct code for your brand of Cable box, tune your Cable box to channel 02, leave the Cable box and TV ON, and then press ENTER. Screen 10 appears.

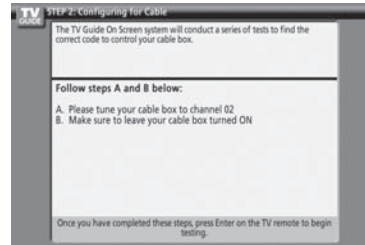

**Screen 10:** The TV Guide On Screen system will test the code for the brand of Cable box you selected. Do not press any keys on the TV, remote control, or Cable box until the testing process is completed. When testing is completed, screen 11 appears.

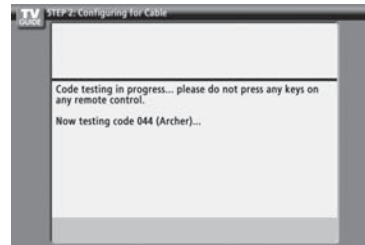

**Screen 11:** If your Cable box tuned itself to channel 09 after testing, select YES and press ENTER. If you selected ANT 1 in screen 5, screen 13 appears. If you selected VIDEO 1 in screen 5, screen 12 appears.

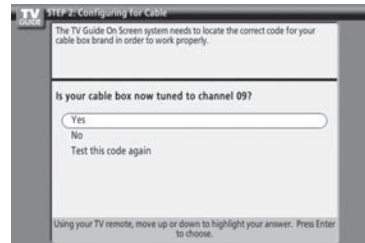

If your Cable box did not tune itself to channel 09 after testing and you want to test the same code again, select **TEST THIS CODE AGAIN** and press ENTER.

If you want to test a different code, select **NO** and press ENTER. Screen 10 appears.

**Note:** Many cable boxes require testing more than one code.

(Continued on next page)

## Setting up the TV Guide On Screen system (continued)

**Screen 12:** Do you have an antenna connected?  
Select either YES or NO, and then press ENTER. Screen 13 appears.

**Note:** If you selected NO in screen 3, you must select YES in this screen to receive a channel lineup and program listings.

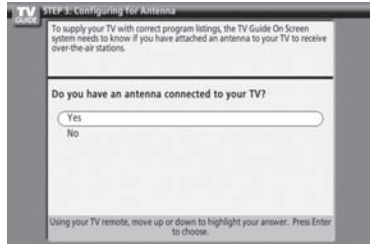

**Screen 13:** Are the settings correct?  
If you select YES, screen 14 appears.  
If you select NO, screen 1 appears.

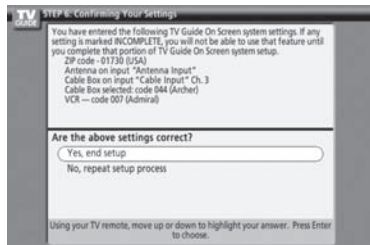

**Screen 14:** Congratulations! You have completed basic TV Guide On Screen system setup.

**Note:** Read the on-screen information regarding the amount of time it may take for listing information to download from the TV Guide On Screen service.

Press ENTER to display screen 15.



**Screen 15:** Is a VCR connected?  
If you select YES, screen 16 appears.  
If you select NO, screen 21 appears.

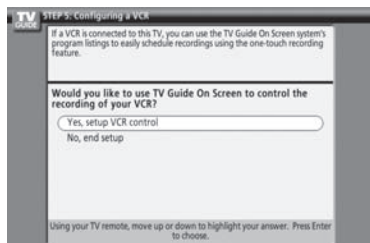

**Screen 16:** The on-screen diagram shows the correct way to connect your VCR to the G-LINK™ jack on the TV. **Make sure the G-LINK cable is installed properly. For additional details, see page 25.**  
Press ENTER to display screen 17.

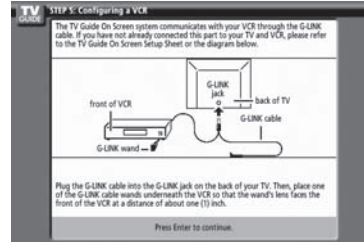

**Screen 17:** Select your VCR brand, and then press ENTER. Screen 18 appears.

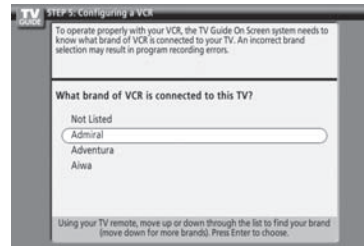

**Screen 18:** Turn on your VCR, insert a tape (either blank or previously recorded), and then press PLAY. Screen 19 appears.

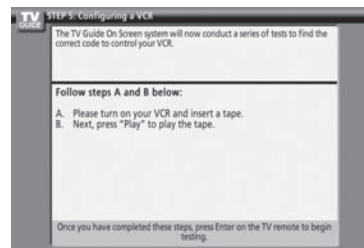

**Screen 19:** The TV Guide On Screen system will test the code for the brand of VCR you selected. Do not press any keys on the TV, remote control, or VCR until the testing process is completed. When testing is completed, screen 20 appears.

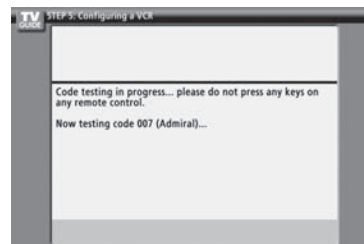

## Setting up the TV Guide On Screen system (continued)

**Screen 20:** If your VCR stopped playing the tape after testing, select YES and press ENTER. Screen 21 appears.

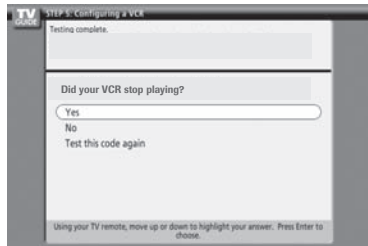

If your VCR did not stop playing the tape after testing and you want to test the same code again, select TEST THIS CODE AGAIN and press ENTER.

If you want to test a different code, select NO and press ENTER. Screen 19 appears.

**Note:** Many VCRs require testing more than one code.

**Screen 21:** Review the setup information displayed on your TV screen (an example is shown below).

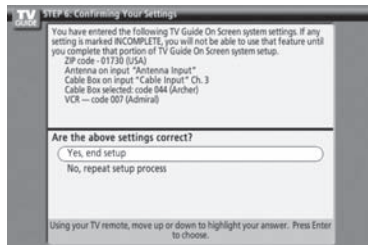

If the information on your TV screen is correct for your setup, select YES, END SETUP and press ENTER. Screen 22 appears.

If the information is incorrect, select NO, REPEAT SETUP PROCESS and press ENTER. Screen 1 appears.

**Screen 22:** Congratulations! You have successfully completed TV Guide On Screen system setup. Press ENTER to display screen 23.



**Screen 23:** This screen provides helpful information on using your TV Guide On Screen system. Press ENTER to exit the TV Guide On Screen setup and watch TV.



### TV Guide On Screen Reminder

The TV Guide On Screen system receives program listings data through your Cable or over-the-air video signal. In order to receive regular program listings, please remember to do the following:

1. Leave the TV in standby mode when it is not in use (such as overnight or when you are not watching it) by turning it OFF but leaving the power cord plugged in.
2. If you have a Cable box connected, leave it ON.
3. If you have a VCR connected, turn it OFF when not in use. (Do not unplug the power cord.) See page 13 for VCR connection instructions.
4. If you have more than one Cable system in your area, you may be prompted to select which Cable system's program data to download. If so prompted, follow the on-screen instructions.

## 6 Setting up your TV

For menu navigation instructions, see Chapter 4.

### Selecting the menu language

You can choose from three different languages (English, French and Spanish) for the on-screen display of adjustment menus and messages. (The TV Guide On Screen menus are in English, regardless of the language selected in this menu.)

#### To select the menu language:

1. Press MENU and open the PREFERENCES menu.
2. Highlight MENU LANGUAGE and press ENTER.
3. Highlight your preferred menu language in the menu sidebar and press ENTER.

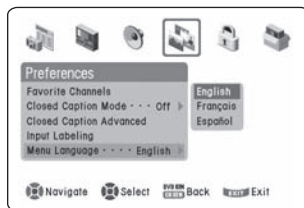

4. Press EXIT to close the PREFERENCES menu.

### Configuring the antenna input sources

#### To configure the ANT 1 and ANT 2 input sources:

1. Press MENU and open the SETUP menu.
2. Highlight INSTALLATION and press ENTER. (A new set of INSTALLATION menu icons will appear on-screen, as shown in step 3 below.)

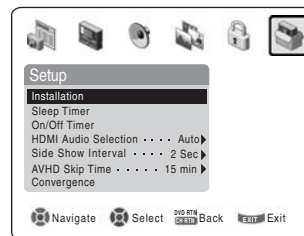

3. Open the TERRESTRIAL menu, highlight INPUT CONFIGURATION, and press ENTER.

**Note:** The TERRESTRIAL menu may not be accessible (items will be "grayed out") in some instances (for example, if a cable box is connected to the ANT 1 input or if one of the VIDEO modes is the current input during TV Guide On Screen setup).

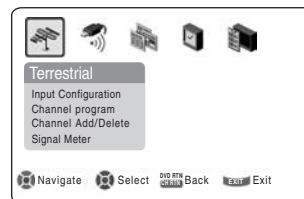

4. Press ► to select the input source (Cable or antenna) for the ANT 1 input on the TV.

**Note:** If a cable box is connected to the ANT 1 input during TV Guide On Screen setup, the entire TERRESTRIAL menu will not be accessible, including the input source for ANT 1, which will automatically display "Cable Box."

5. Press ▼ and then ► to select the input source (Cable or antenna) for the ANT 2 input on the TV, if applicable. If you have not connected anything to ANT 2, skip this step.

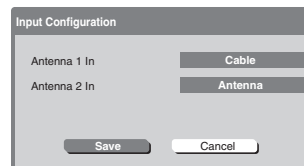

6. **To save your new settings:** Highlight SAVE and press ENTER.

**To revert to your original settings:** Highlight CANCEL and press ENTER before saving.

## Programming channels into the TV's channel memory

When you press CHANNEL ▲ or ▼ on the remote control or TV front panel, your TV will stop only on the channels stored in the TV's channel memory.

Follow the steps below to program channels into the TV's channel memory.

### Programming channels automatically

Your TV can automatically detect all active channels in your area and store them in its memory. After the channels are programmed automatically, you can manually add or erase individual channels.

**Note:**

- You must configure the antenna input sources before programming channels (see page 40).
- The automatic channel programming process does NOT erase channels that were previously programmed into the TV's memory, but adds newly found channels to the existing set of programmed channels. To remove a channel from the memory, you must manually delete it (see next page).
- To tune the TV to a channel not programmed in the channel memory, you must use the Channel Number buttons on the remote control.
- Programming channels for an antenna input configured for CABLE will take substantially longer than for an antenna input configured for ANTENNA. This is normal; however, once channel programming is completed, you should not have to repeat the programming process again unless your Cable TV service lineup changes significantly.
- If you have a CableCARD inserted (page 12), channel programming for ANT 1 is disabled because the CableCARD automatically loads the Cable channel list in the TV's channel memory.

**To program channels automatically:**

1. Make sure you have configured the antenna input sources. See page 41 for details.
2. Press MENU and open the SETUP menu.
3. Highlight INSTALLATION and press ENTER. (A new set of INSTALLATION menu icons will appear on-screen.)

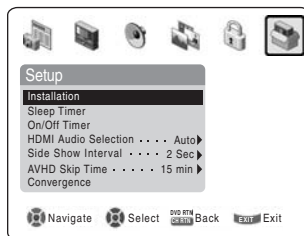

4. Open the TERRESTRIAL menu, highlight CHANNEL PROGRAM, and press ENTER.
5. Highlight ANT 1 or ANT 2, depending on which antenna input you want to program channels for, and then press ENTER to start automatic channel programming.

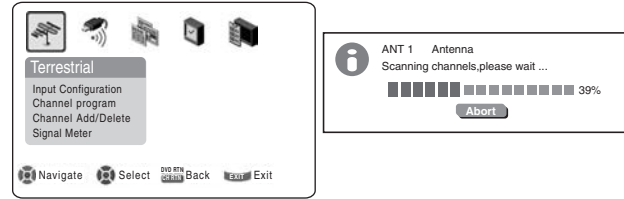

The TV will automatically cycle through all the channels for the antenna input you selected, and store all active channels in the channel memory. While the TV is cycling through the channels, the message "Scanning channels, please wait" appears (as shown above right).

To cancel channel programming, either press EXIT or highlight ABORT in the on-screen display and press ENTER.

6. When channel programming is done, press CHANNEL ▲ or ▼ to view the programmed channels.

(Continued on next page)

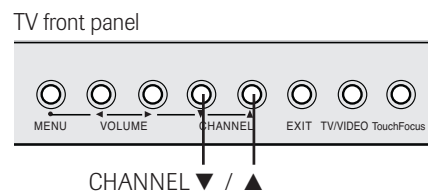
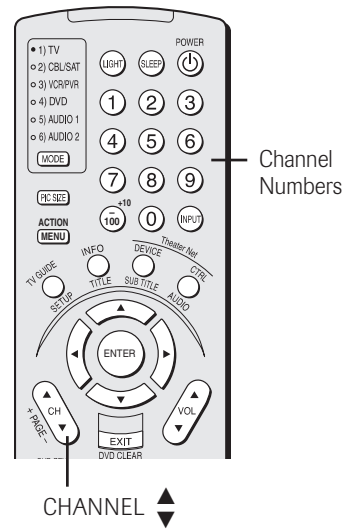



## Programming channels into the TV's channel memory (continued)

### Manually adding and deleting channels in the channel memory

After you have programmed the channels automatically, you can manually add or delete individual channels in the channel memory.

#### To add or delete channels in the channel memory:

1. Press MENU and open the SETUP menu.
2. Highlight INSTALLATION and press ENTER. (A new set of INSTALLATION menu icons will appear on-screen, as shown in step 3).

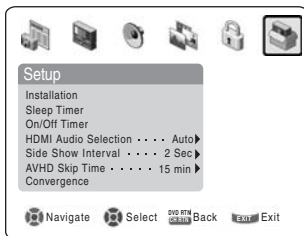

3. Open the TERRESTRIAL menu, highlight CHANNEL ADD/DELETE, and then press ENTER.

**Note:** If you have a cable box connected to ANT 1 during TV Guide On Screen setup, the TERRESTRIAL menu will not be accessible and you must then use the TV Guide On Screen channel editor to add/delete channels.

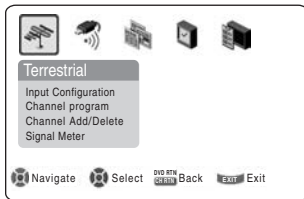

4. The illustration below shows channels programmed for the ANT 1 antenna input. To view the list of channels programmed for the ANT 2 antenna input, highlight CHANGE ANTENNA and press ENTER.

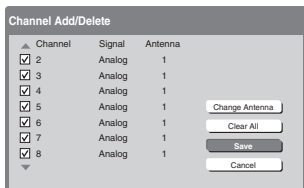

#### To add a channel to the channel memory:

Highlight the unchecked box next to the channel number you want to add, and then press ENTER to check the box.

#### To manually add digital subchannels on a physical channel:

Use the Channel Numbers and the Dash (–/100) on the remote control to enter the channel number (for example, 56–1).

If the channel is found, the number will be added to the list and the box will be checked.

If the channel is not found, a message will appear.

#### To remove a channel from the channel memory:

Highlight the checked box next to the channel number you want to remove, and then press ENTER to uncheck the box.

#### To save your new settings:

Highlight SAVE and press ENTER.

#### To revert to your original settings:

Highlight CANCEL and press ENTER before saving.

#### To remove all channels from the channel memory:

Highlight CLEAR ALL and press ENTER, and then highlight SAVE and press ENTER.

#### Note:

- This action applies to the current antenna input only. To delete/add channels on the other input, highlight CHANGE ANTENNA and press ENTER.
- This action cannot be cancelled unless you highlight CANCEL and press ENTER before saving your changes.

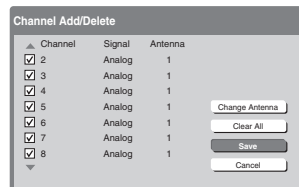

## Programming your favorite channels

You can program a maximum of 18 of your favorite channels (9 from the ANT 1 input and 9 from the ANT 2 input) into the Favorite Channels sets (two sets of nine favorite channels). You can then scan through your favorite channels only, skipping other channels you do not normally watch.

### To add and delete channels in the Favorite Channels lists:

1. Press MENU and open the PREFERENCES menu.
2. Highlight FAVORITE CHANNELS and press ENTER.
3. Highlight EDIT and press ENTER.

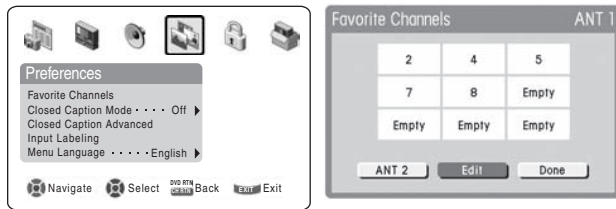

4. **To add the channel to the Favorite Channels set:**  
Use the ▲▼◀▶ buttons to highlight an unchecked box next to a channel you want to set as a favorite, and then press ENTER to check the box.

**To delete the channel from the Favorite Channels set:**  
Highlight a checked box and press ENTER to uncheck it.

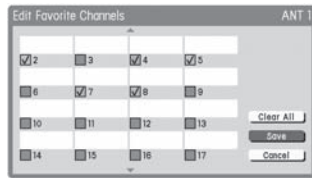

If you try to add more than 9 favorite channels per antenna input, an error message appears. You will need to deselect a channel before you can add another.

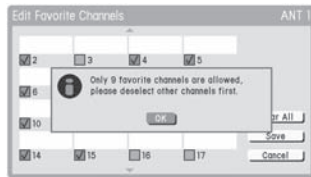

5. When done, highlight SAVE and press ENTER.
6. To program favorite channels for the other antenna input:  
*Either...* Highlight ANT 1 or ANT 2, which will change the favorite channel settings in the selected input. (This will not change the TV's current input.)  
*Or...* Press INPUT to select ANT 1 or ANT2, and then repeat steps 1–6.

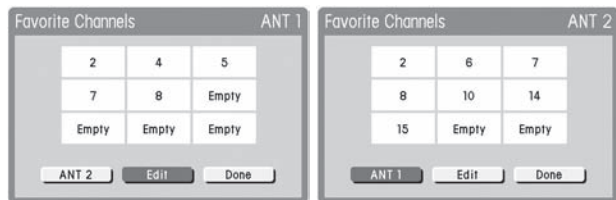

### To clear your favorite channel lists:

1. Press MENU and open the PREFERENCES menu.
2. Highlight FAVORITE CHANNELS and press ENTER.
3. Highlight EDIT and press ENTER.
4. Highlight CLEAR ALL and press ENTER.
5. Highlight SAVE and press ENTER.

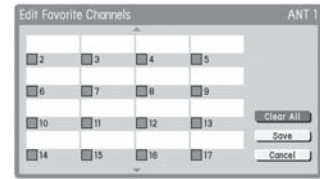

### To tune your favorite channels for the current ANT input:

Press FAV CH ▲▼.

**Note:** To tune your favorite channels for the other antenna input, you will need to change the Input Selection to the other ANT mode first.

### To quickly scan through your favorite channels in a nine-picture multi-window (for the current ANT input):

Press FAV SCAN. See page 76 for details.

#### Note:

- To tune to a channel from the FAV SCAN mode, highlight a window (will be outlined with a green border) and press ENTER.
- To scan your favorite channels for the other antenna input, you will need to change the Input Selection to the other ANT mode first.

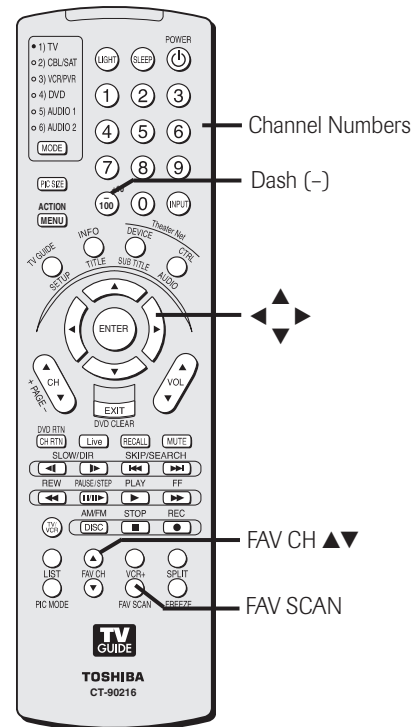

## Setting up and using TheaterNet™ on-screen device control

The TheaterNet feature allows you to control many brands of IEEE-1394 and/or infrared remote-controlled A/V devices through your TV using on-screen control icons and the TV's remote control.

### Note:

- Although the TheaterNet on-screen device control feature includes codes for many devices, it may not include codes for some or all of the features on certain devices you wish to control. If you are unable to program the TheaterNet feature to operate your device or some of the features on that device, use the device's remote control or the controls on the device.
- For IR pass-through device control information, see "Connecting infrared remote-controlled devices to the IR OUT jack" on page 21.

## Setting up TheaterNet

All device types except IEEE-1394 require the following setup process before you can control them using the TheaterNet on-screen icons.

All Compatible IEEE-1394 devices are automatically recognized by the TheaterNet feature and do not require setup.

**Note:** See page 22 for details about the IEEE-1394 ports. If your IEEE-1394 device is not recognized through the IEEE-1394 port or through the TheaterNet feature, it may be possible to set it up for IR pass-through control as an infrared device (see page 21).

### To set up TheaterNet device control:

1. Make sure you have properly connected your infrared remote-controlled device(s). See page 21 for details.
2. Press MENU and open the SETUP menu.
3. Highlight INSTALLATION and press ENTER. (A new set of INSTALLATION menu icons will appear on-screen, as shown in step 4).

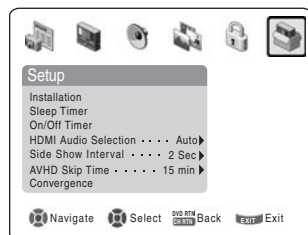

4. Open the DEVICES menu, highlight THEATER NET DEVICES, and then press ENTER.

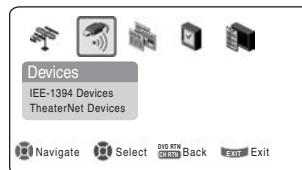

The TheaterNet Setup menu opens.

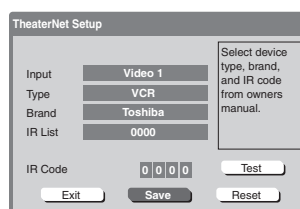

5. Using the ◀▶ buttons, select the INPUT the device is connected to.

**Note:** When the input is changed, all unsaved settings will be lost.

6. Press ▼ and then ◀▶ to select the device TYPE.

7. Press ▼ and then ◀▶ to select the device BRAND.

**Note:** When selecting a new brand, the IR code will be set to zero.

8. Press ▼ and then ◀▶ to select the device's IR code.

9. If the desired IR code is found, skip to step 10.

If the desired IR code is not in the list, press ▼ and use the Channel Number buttons to enter the device IR code.

**Note:** You can find the IR code for your device in the on-screen list or in the TheaterNet device code table on pages 46–48.

10. Highlight TEST and press ENTER to test whether the device responds to the code.

If the device does not respond to the code, repeat steps 8 and 9 using another code for the same device.

11. When done, highlight SAVE and press ENTER.

### To remove a device from TheaterNet:

1. Follow steps 1–5 above.
2. Highlight RESET and press ENTER.
3. Highlight SAVE and press ENTER.

## Setting up and using TheaterNet™ on-screen device control (continued)

### Using the TheaterNet control icons

1. Set up your infrared devices in TheaterNet, if you have not already done so (see page 44).

**Note:** IEEE-1394 devices do not need to be set up in TheaterNet because they appear automatically in the TheaterNet menu (as shown in step 3 below).

2. Press DEVICE on the remote control to display the device control selection screen.

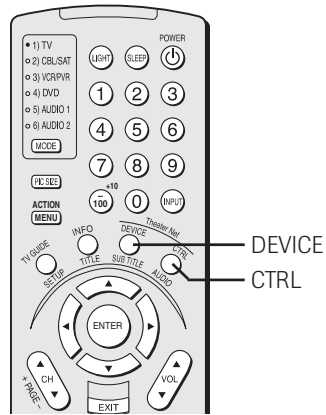

3. Using the ▲▼◀▶ buttons, highlight the device you want to control and press ENTER.

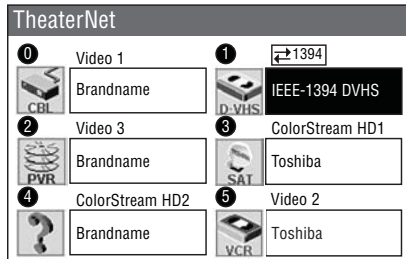

4. The input automatically changes to the input for the selected device and the device's control icons display.

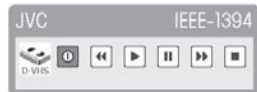

Highlight the icon for the function you want to control and press ENTER.

#### To select the device's control icons directly:

Press CTRL.

#### To close the on-screen control icons:

Press EXIT.

#### To view another source:

Press DEVICE and select the input source you want to view.

The following are examples of the TheaterNet on-screen control icons for other types of devices.

Toshiba Symbio™ AVHD device control

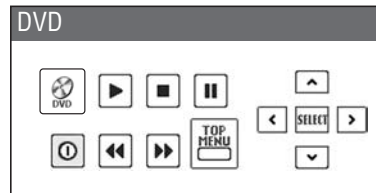

## TheaterNet™ IR device codes

**Amplifiers**

Brand	Code
Aiwa	0406
Bose	0674
Carver	0269
Curtis Mathes	0300
Denon	0160
GE	0078
Harman/Kardon	0892
JVC	0331
Left Coast	0892
Linn	0269
Luxman	0165
Magnavox	0269
Marantz	0892, 0321, 0269
NEC	0264
Nakamichi	0321
Optimus	0395, 0300
Panasonic	0308, 0521
Parasound	0246
Philips	0892, 0269
Pioneer	0013, 0300
Polk Audio	0892, 0269
RCA	0300
Realistic	0395
Sansui	0321
Shure	0264
Sony	0689, 0220
Soundesign	0078, 0211
Technics	0308, 0521
Victor	0331
Wards	0078, 0013, 0211
Yamaha	0354, 0133

**Cable boxes**

Brand	Code
ABC	0003, 0008, 0014, 0007, 0011, 0017
Americast	0899
Bell & Howell	0014
Bell South	0899
Contec	0019
Director	0476
Everquest	0015
Gemini	0015
General Instrument	0476, 0003, 0276, 0011, 0810
GoldStar	0144
Hamlin	0009, 0020, 0273
Hitachi	0011
Hytex	0007
Jasco	0015
Jerrold	0476, 0003, 0276, 0012, 0014, 0015, 0011, 0810
Memorex	0000
Motorola	0476, 1106, 0276, 0810
Oak	0019, 0007
Pace	0237
Panasonic	0000, 0107
Paragon	0000
Philips	0305, 0317
Pioneer	0877, 0144, 0533, 1877
Pulsar	0000
Quasar	0000

**Cable boxes (cont.)**

Brand	Code
RadioShack	0015
Regal	0020, 0273, 0279
Rembrandt	0011
Runco	0000
Samsung	0144
Scientific Atlanta	0877, 0008, 0017, 0477, 1877
Signal	0015
Signature	0011
sony	1006
Starcom	0003, 0015
Stargate	0015
Starquest	0015
Supercable	0276
Tocom	0012
Torx	0003
Toshiba	0000
Tusa	0015
United Artists	0007
Zenith	0000, 0525, 0899

**CD players**

Brand	Code
Aiwa	0157, 0124
Burmester	0420
California Audio Labs	0029, 0303
Carver	0157, 0179, 0437
Classic	1297
DKK	0000
DMX Electronics	0157
Denon	0873, 0003
Emerson	0305
Fisher	0174, 0179, 1325
GPX	1296
Garrard	0393, 0420
Genexxa	0032, 0305
Harman/Kardon	0157, 0173
Hitachi	0032
JVC	0072, 1294
KLH	1318, 1372, 1373
Kenwood	0681, 0826, 0626, 0028, 0037, 0190
Koss	1317
Krell	0157
LXI	0305
Linn	0157
MCS	0029
MTC	0420
Magnavox	0157, 0305
Marantz	0626, 0029, 0157, 0180
Miro	0000
Mission	0157
NSM	0157
Nikko	0174
Onkyo	0868, 0101
Optimus	1063, 0000, 0032, 0037, 0145, 0179, 0305, 0420, 0437, 0468
Panasonic	0029, 0303
Parasound	0420
Philips	0626, 0157
Pioneer	1063, 1062, 0032, 0305, 0468
Polk Audio	0157

**CD players (cont.)**

Brand	Code
Proton	0157
QED	0157
Quasar	0029
RCA	1062, 0032, 0053, 0179, 0305, 0468, 0764
Realistic	0179, 0180, 0420
Rotel	0157, 0420
SAE	0157
Sansui	0157, 0305
Sanyo	0179
Scott	0305
Sears	0305
Sharp	0861, 0037, 0180
Sherwood	1067, 0180
Sonic Frontiers	0157
Sony	0490, 0000, 0100, 0185, 0604, 1364
Soundesign	0145
TDK	1208
Tascam	0420
Teac	0174, 0180, 0393, 0420
Technics	0029, 0303
Victor	0072
Wards	0157, 0053
Yamaha	0888, 0036, 0187, 1292
Yorx	0461

**Laser disk players**

Brand	Code
Aiwa	0203
Carver	0064, 0194, 0323
Denon	0059, 0172
Disco Vision	0023
Funai	0203
Harman/Kardon	0194
Hitachi	0023
Magnavox	0194, 0217
Marantz	0064, 0194
Mitsubishi	0059
NAD	0059
Optimus	0059
Panasonic	0204
Philips	0064, 0194
Pioneer	0059, 0023
Polk Audio	0194
Quasar	0204
Realistic	0203
Samsung	0323
Sega	0023
Sony	0193, 0201
Technics	0204
Theta Digital	0194
Yamaha	0217

**Miscellaneous audio devices**

Brand	Code
Aiwa	0010, 0159, 0404
Fisher	0052
JVC	0073
Jerrold	0520, 0459
Scientific Atlanta	0460
Sony	0010, 0159, 0576
Starcom	0459



## TheaterNet™ IR device codes (continued)

## Video accessory (HDTV decoder)

Brand	Code
Panasonic	1120
Pioneer	1010
Princeton	0113, 0295
Samsung	1190
Sensory Science	1126
Sharp	1010

## Receivers

Brand	Code
ADC	0531
Aiwa	1089, 1405, 0121, 0158, 0189, 0405, 1388, 1641
Alco	1390
Anam	1609
Apex Digital	1257
Arcam	1120
Audiotronic	1189
Audiovox	1390
Bose	1229
Cambridge Soundworks	1370
Capetronic	0531
Carver	1089, 1189, 0042, 0189
Casio	0195
Clarinette	0195
Compaq	1136
Curtis Mathes	0080
Daewoo	1250
Denon	1104, 1160, 0004, 1360
Fisher	0042, 1801
Garrard	0463
Harman/Kardon	0110, 0189, 0891
Hewlett Packard	1181
JBL	0110, 1306
JVC	0074, 1374
KLH	1390
Kenwood	1313, 1027, 1570, 1569, 0027, 0042, 0186
Koss	1366
LXI	0181
Lasonic	1798
Linn	0189
Lloyd's	0195
MCS	0039
Magnavox	1089, 1189, 0189, 0195, 0391, 0531
Marantz	1089, 1189, 0039, 0189
Modulaire	0195
Musicmagic	1089
Nakamichi	0097
Onkyo	0135, 0842, 1298
Optimus	1023, 0042, 0080, 0181, 0186, 0531, 0670, 0738, 0801
Panasonic	1518, 0039, 0309, 0367
Penney	0195
Philips	1089, 1189, 1269, 0189, 0391, 1120
Pioneer	1023, 0014, 0080, 0150, 0244, 0531, 0630, 1384
Polk Audio	0189

## Receivers (cont.)

Brand	Code
Proscan	1254
Quasar	0039
RCA	1023, 1254, 0080, 0531, 1390, 1609
Realistic	0181, 0195
Samsung	1295
Sansui	1089, 0189
Sanyo	0801, 1251
Sharp	0186, 1286
Sherwood	0491, 0502, 1653
Sony	1058, 1258, 1158, 0158, 0474, 1367, 1558, 1658, 1758
Soundesign	0670
Stereophonics	1023
Sunfire	1313
Teac	0463
Technics	1308, 1309, 1518, 0039, 0309
Thorens	1189
Venturer	1390
Victor	0074
Wards	0014, 0080, 0158, 0189
Yamaha	0176, 0186, 1176
Yorx	0195
Zenith	0857

## Satellite receivers

Brand	Code
AlphaStar	0772
Chaparral	0216
Crossdigital	1109
DishPro	1005, 0775
Echostar	1005, 0775
Expressvu	0775
GE	0566
GOI	0775
General Instrument	0869
HTS	0775
Hitachi	0819
Hughes Network Systems	1142, 0749, 1749
JVC	0775
Magnavox	0724, 0722
Memorex	0724
Mitsubishi	0749
Motorola	0869
Next Level	0869
Panasonic	0247, 0701
Paysat	0724
Philips	1142, 0749, 0724, 1076, 0722, 1749
Proscan	0392
RCA	0392, 0566, 0855, 0143
RadioShack	0869
SKY	0856
Samsung	1109
Sony	0639
Star Choice	0869
Toshiba	0749, 0790, 1052, 1053, 1054, 1285, 1286, 1287, 1289, 1749
Uniden	0724, 0722
Zenith	0856, 1856

## VCRs

Brand	Code
Admiral	0048, 0209
Adventura	0000
Aiko	0278
Aiwa	0037, 0000
Akai	0041
America Action	0278
American High	0035
Asha	0240
Audiovox	0037, 0278
Beaumarck	0240
Bell & Howell	0104
Broksonic	0184, 0121, 0209, 0002, 0479, 1479 0072, 0278
CCE	0037
Calix	0037
Canon	0035
Carver	0081
Cineral	0278
Citizen	0037, 0278, 1278
Colt	0072
Craig	0037, 0047, 0240, 0072
Curtis Mathes	0060, 0035, 0162, 0041, 0760, 1035
Cybernex	0240
Daewoo	0045, 0278, 1278
Denon	0042
Dynatech	0000
Electrohome	0037
Electrohome	0037
Emerex	0032
Emerson	0037, 0184, 0000, 0121, 0043, 0209, 0002, 0278, 0479, 1278, 1479
Fisher	0047, 0104
Fuji	0035, 0033
Funai	0000
GE	0060, 0035, 0240, 0760, 0807, 1035, 1060
Garrard	0000
Go Video	0432
GoldStar	0037, 0038, 1237
Gradiente	0000
HI-Q	0047
Harley Davidson	0000
Harman/Kardon	0081, 0038
Harwood	0072
Headquarter	0046
Hitachi	0000, 0042, 0041
Hughes Network Systems	0042
JVC	0067, 0041
Jensen	0041
KEC	0037, 0278
KLH	0072
Keen	0693
Kenwood	0067, 0041, 0038
Kodak	0035, 0037
LXI	0037
Lloyd's	0000
Logik	0072
MEI	0035
MGA	0240, 0043
MGN Technology	0240
MTC	0240, 0000
Magnasonic	1278

## TheaterNet™ IR device codes (continued)

## VCRs (cont.)

Brand	Code
Magnavox	0035, 0039, 0081, 0000, 0149, 0563, 1781
Magnin	0240
Marantz	0035, 0081
Marta	0037
Matsushita	0035, 0162, 0454
Memorex	0035, 0162, 0037, 0048, 0039, 0047, 0240, 0000, 0104, 0209, 0046, 0454, 0479, 1037, 1162, 1237, 1262
Minolta	0042
Mitsubishi	0067, 0043, 0807
Motorola	0035, 0048
Multitech	0000, 0072
NEC	0104, 0067, 0041, 0038
Nikko	0037
Noblex	0240
Olympus	0035
Optimus	1062, 0162, 0037, 0048, 0104, 0432, 0454, 1048, 1162, 1262
Orion	0184, 0209, 0002, 0479, 1479
Panasonic	1062, 0035, 0162, 0225, 0454, 0616, 1035, 1162, 1262
Penney	0035, 0037, 0240, 0042, 0038, 1035, 1237
Pentax	0042
Philco	0035, 0209, 0479
Philips	0035, 0081, 0618, 1081, 1181
Pilot	0037
Pioneer	0067
Polk Audio	0081
Profitronic	0240
Proscan	0060, 0760, 1060
Protec	0072
Pulsar	0039
Quarter	0046
Quartz	0046
Quasar	0035, 0162, 0454, 1035, 1162
RCA	0060, 0240, 0042, 0149, 0760, 0807, 1035, 1060
RadioShack	0000, 1037
Radix	0037
Randex	0037
Realistic	0035, 0037, 0048, 0047, 0000, 0104, 0046
ReplayTV	0614, 0616
Runco	0039
STS	0042
Samsung	0240, 0045
Sanky	0048, 0039
Sansui	0000, 0067, 0209, 0041, 0479, 1479
Sanyo	0047, 0240, 0104, 0046

## VCRs (cont.)

Brand	Code
Scott	0184, 0045, 0121, 0043
Sears	0035, 0037, 0047, 0000, 0042, 0104, 0046, 1237
Semp	0045
Sharp	0048, 0807, 0848
Shintom	0072
Shogun	0240
Singer	0072
Sonic Blue	0614, 0616
Sony	0035, 0032, 0000, 0033, 0636, 1032, 1232
Sylvania	0035, 0081, 0000, 0043, 1781
Symphonic	0000
TMK	0240
Tatung	0041
Teac	0000, 0041
Technics	0035, 0162
Teknika	0035, 0037, 0000
Thomas	0000
Tivo	0618, 0636
Toshiba	0045, 0043, 0845
Totevision	0037, 0240
Unitech	0240
Vector	0045
Vector Research	0038
Video Concepts	0045
Videomagic	0037
Videosonic	0240
Villain	0000
Wards	0060, 0035, 0048, 0047, 0081, 0240, 0000, 0042, 0072, 0149, 0760
White Westinghouse	0209, 0072, 1278
XR-1000	0035, 0000, 0072
Yamaha	0038
Zenith	0039, 0000, 0209, 0033, 0479, 1479

## DVD players

Brand	Code
Aiwa	0641
Apex Digital	0672, 0717, 0755, 0794, 0796, 0797, 0830, 0856, 1100
Audiologic	0736
B & K	0655, 0662
Blue Parade	0571
Broksonic	0695
DVD2000	0521
Daewoo	0784
Denon	0490, 0634
Emerson	0591
Enterprise	0591
Fisher	0670
GE	0522, 0717
GPX	0699, 0769
Go Video	0715
Gradiente	0651
Greenhill	0717
Harman/Kardon	0582, 0702

## DVD players (cont.)

Brand	Code
Hitachi	0573, 0664
Hiteker	0672
JBL	0702
JVC	0558, 0623, 0867
KLH	0717
Kenwood	0490, 0534, 0682, 0737
Konka	0711, 0719, 0720, 0721
Koss	0651
Lasonic	0798
Magnavox	0503, 0675
Malata	0782
Marantz	0539
Microsoft	0522
Mintek	0717
Mitsubishi	0521
Nesa	0717
Next Base	0826
Norcent	0872
Onkyo	0503, 0627
Oritron	0651
Panasonic	0490, 0632, 1362, 1462, 1490
Philips	0503, 0539, 0646, 0854
Pioneer	0525, 0571, 0632
Polk Audio	0539
Princeton	0674
Proscan	0522
RCA	0522, 0571, 0717, 0822
Rotel	0623
Rowa	0823
Sampo	0698
Samsung	0573, 0820
Sansui	0695
Sanyo	0670
Sharp	0630
Sherwood	0633
Shinsonic	0533
Sony	0533, 0864, 1533
Sylvania	0675, 0821
Technics	0490
Techwood	0692
Theta Digital	0571
Toshiba	0503, 0695, 1045
Tredex	0800
Urban Concepts	0503
XBox	0522

## Adjusting the color convergence

This projection TV uses three separate image tubes: red, green, and blue. The red, green, and blue images are projected onto the screen where they converge to form a full-color picture. You can see a clear picture only when the three images converge correctly. Convergence may drift over time or if you move the TV. If you can see clear images on your TV screen, skip this procedure.

This adjustment should be made only after the TV has been on for at least 30 minutes.

### Automatically adjusting the color convergence using TouchFocus®

To automatically adjust the color convergence:

Press TouchFocus on the TV front panel one time.

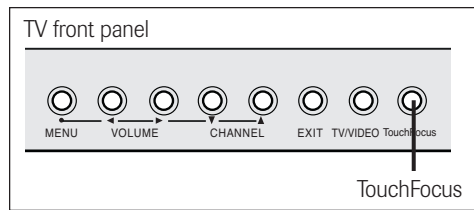

The TV will enter the auto convergence mode.

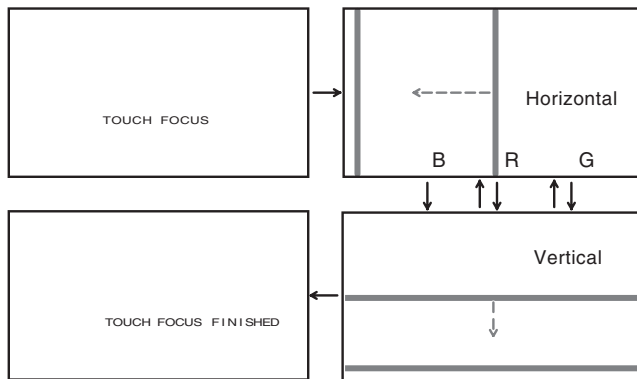

When adjustment is complete, the normal picture will reappear.

You can adjust the convergence manually described at right for more detailed convergence adjustment.

### Manually adjusting the color convergence

To check and adjust the color convergence manually:

1. Press MENU and open the SETUP menu.
2. Highlight CONVERGENCE and press ENTER.

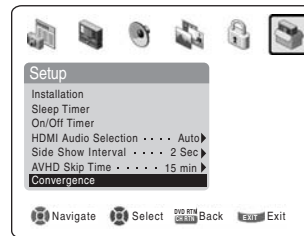

3. When the convergence screen appears, press ENTER. The TV will enter auto-convergence mode. When the adjustment is complete, the TV will enter 56-point convergence mode automatically.

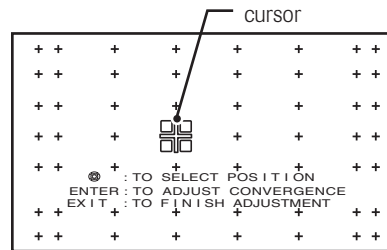

If you see separate red, blue, or green crossed lines (or red or blue shadows next to white lines), you need to adjust the convergence.

4. Press ▲▼◀▶ to move the cursor to the position you want to adjust.
5. Press ENTER repeatedly to select RED or BLUE adjusting mode (red crossed lines or blue crossed lines), depending on which color needs adjusting.
6. Press ▲ (up), ▼ (down), ◀ (left), or ▶ (right) on the remote control to converge the red or blue line into the white line.

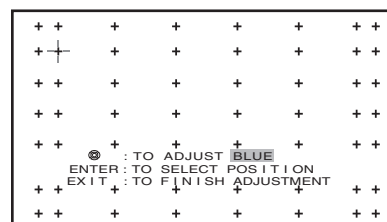
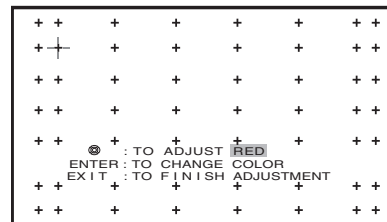

## Adjusting the color convergence

(continued)

7. If both red and blue need adjusting, you will need to perform steps 5 and 6 twice.
8. Press ENTER to display the cursor.
9. Repeat steps 4 to 8 to adjust another position.
10. Press EXIT to close the Convergence menu.

### To reset your convergence adjustments:

1. Press MENU and open the SETUP menu.
2. Highlight CONVERGENCE and press ENTER.
3. Press RECALL.  
The message, "WARNING: RESETS USER ADJUSTMENT TO FACTORY SETTINGS" appears.
4. Press ENTER to reset your convergence adjustments to the factory settings.

## Setting the AVHD device skip time

When you connect an external AVHD device, such as the Toshiba Symbio™ 160HD4 AVHD (audio/video hard drive) to one of the TV's IEEE-1394 ports, you can use this feature to set the number of minutes the device will skip forward or backward when you press the SKIP buttons.

### Note:

- This TV will work best with the Toshiba Symbio™ 160HD4 AVHD, for recording high definition and standard definition material from either tuner and for controlling live TV (pause/rewind/fast forward/skip). When the AVHD is connected to the TV, the remote control keys (STOP, REW, PAUSE, PLAY, FF) are automatically activated to allow pausing of live TV.
- When you connect an AVHD (or a D-VHS) device, the TV Guide On Screen system is automatically configured to allow recording.  
See page 23 for device connection information.  
See Chapters 5 and 7 for details about setting up and using the TV Guide On Screen system.

### To set the AVHD device skip time:

1. Press MENU and open the SETUP menu.
2. Highlight AVHD SKIP TIME and press ENTER.
3. Press ▼ or ▲ to select the AVHD skip time and press ENTER.

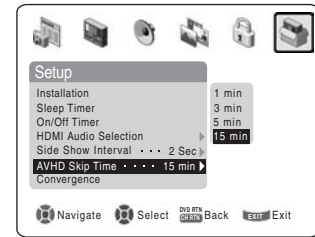

## Selecting the HDMI™ 1 or HDMI 2 audio mode

### To select the HDMI audio mode:

1. Press MENU and open the SET UP menu.
2. Highlight HDMI AUDIO SELECTION and press ENTER.
3. Press ▼ or ▲ to select which HDMI device for which you want to select audio and press ENTER.
4. Press ▼ or ▲ to select the HDMI audio mode from Auto, Digital, or Analog (Auto is recommended). See "Connecting an HDMI or a DVI device to the HDMI input on page 19.

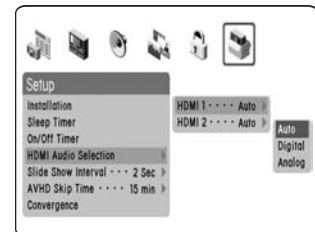

## Setting the time and date

**Note:** If you already set up the TV Guide On Screen system, the time and date were set automatically and you can skip this step.

### To set the time and date:

1. Press MENU and open the SETUP menu.
2. Highlight INSTALLATION and press ENTER. (A new set of INSTALLATION menu icons will appear on-screen, as shown in step 3 below.)
3. Open the TIME AND DATE menu, highlight START SETUP, and press ENTER.

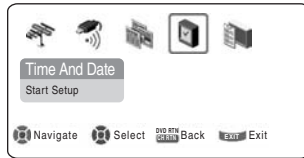
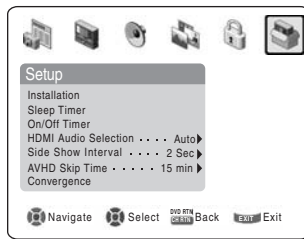

If you have not set up the TV Guide On Screen system, the following screen will appear. To set the time, highlight TV GUIDE ON SCREEN and press ENTER. The TV Guide On Screen setup sequence will start, and the time and date will be set automatically.

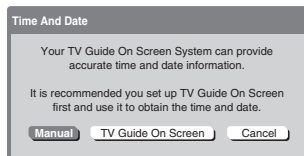

### Note:

- If you highlight TV GUIDE ON SCREEN (above) to set the time and date through the TV Guide On Screen system and a power outage occurs, the time and date will be updated automatically when the power is restored.
- If you highlight MANUAL (above) to set the time and date manually and a power outage occurs, you will lose the time and date settings when the power is restored.
- If you manually set the time and date and then perform TV Guide On Screen setup, the manual time and date settings will be overridden by the TV Guide On Screen settings.

## Viewing the CableCARD™ menu

A CableCARD enables you to view encrypted digital channels. See page 12 for connection and subscription information.

After the CableCARD is inserted, a CableCARD option appears in the APPLICATIONS menu, with informational screens provided by your digital CableCARD service (see illustrations below).

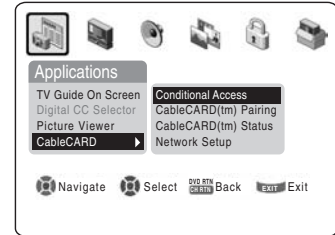
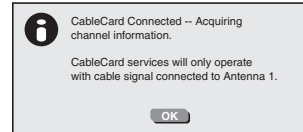

### To view the CableCARD menu:

1. Press MENU and open the APPLICATIONS menu.
2. Highlight CableCARD and press ENTER.
3. A side menu will display. Highlight one of the side menu items and press ENTER to display the information.

**Note:** The CableCARD menu has no user-adjustable options and is for informational purposes only.



## Viewing the digital signal meter

You can view the digital signal meter for ANT 1 and ANT 2 digital TV input sources only.

### To view the digital signal meter:

1. Press MENU and open the SETUP menu.
2. Highlight INSTALLATION and press ENTER. (A new set of INSTALLATION menu icons will appear on-screen, as shown in step 3 below.)

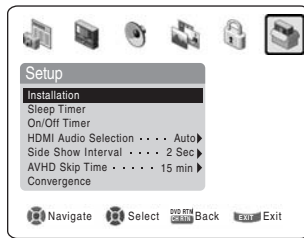

3. Open the TERRESTRIAL menu, highlight SIGNAL METER, and press ENTER.

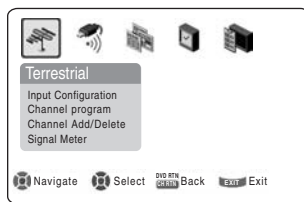

4. Use the ▲▼◀▶ buttons to select the antenna input and digital channel whose signal you want to check.

**Note:** The physical digital channel number listed in the Signal Meter screen may not correspond to a virtual TV channel number. Contact your local broadcasters to obtain the RF channel numbers for your local digital stations.

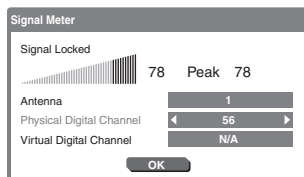

### To close the screen and return to the TERRESTRIAL menu:

Highlight OK and press ENTER.

### To return to normal viewing:

Press EXIT.

## Viewing the system status

### To check the system status:

1. Press MENU and open the SETUP menu.
2. Highlight INSTALLATION and press ENTER. (A new set of INSTALLATION menu icons will appear on-screen, as shown in step 3).
3. Open the SYSTEM STATUS menu, highlight SYSTEM INFORMATION, and then press ENTER.

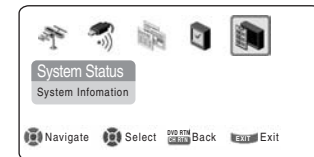
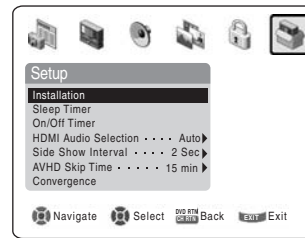

4. Use the ◀▶ buttons to scroll through the menu bar to check the Product Information and Software Version.

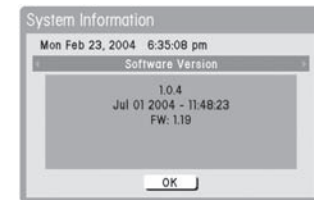

### To close the screen and return to the INSTALLATION menu:

Highlight OK and press ENTER.

### To return to normal viewing:

Press EXIT.

## Restore Factory Defaults

To restore all settings and channels to their factory default values:

1. Follow steps 1–3 above.
2. Use the ◀▶ buttons to scroll through the menu bar to select FACTORY DEFAULTS.
3. The screen below left appears. Enter your PIN code (or 0000 if no PIN code has been set). The screen below right appears.

### To cancel the reset:

Highlight NO and press ENTER.

**To continue the reset process:** Highlight YES and press ENTER. The TV will turn off automatically after a few seconds. After the TV turns off, unplug the TV power cord and then plug it in again to complete the restore.

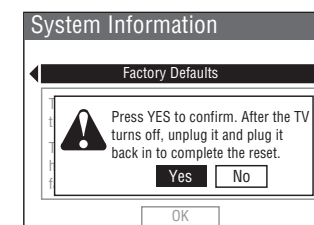
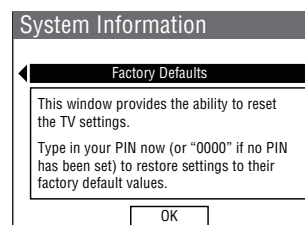

## 7 Using the TV Guide On Screen® interactive program guide

The TV Guide On Screen® system is a free, interactive, on-screen program guide built in to your Toshiba TV that lists schedules and information for TV programs in your area.

**Note:** Over-the-air or cable access to stations carrying TV Guide On Screen data is required for the TV Guide On Screen system to operate. TV Guide On Screen data is not provided by Toshiba America Consumer Products, L.L.C. (TACP); therefore, TACP is not liable for the content of such data. The data provider may elect to discontinue the service or it may cease to be (or never be) available in your area. In any of these circumstances, the TV Guide On Screen feature will not function. TACP is not liable in the event this service is unavailable or for any consequences arising from customers having used or not being able to use this service.

The TV Guide On Screen system includes the following features:

- **Streamlined on-screen assisted setup**—Quickly and easily set up your TV Guide On Screen system using the on-screen prompts (see “Setting up the TV Guide On Screen system” below).
  - **Program listings and INFO windows**—Scroll through eight days of TV listings and view program information such as rating, stereo, HDTV, new episode.
  - **Watch TV and display TV Guide On Screen information simultaneously.**
  - **Channel lineup customization**—Customize your channel lineup so your favorite stations are listed first.
- **Direct tuning**—Directly tune the TV to a current program you want to watch by selecting it in the program guide.
  - **Reminders**—Schedule show reminders that will either display an on-screen notification banner or automatically tune the TV to the channel of the show for which you set the reminder.
  - **Recording**—Easily schedule recording of one or more programs.  
**Note:** A VCR or IEEE-1394 recording device is required for recording. It is recommended that you connect your devices according to the instructions in Chapter 2.
  - **Search**—Search for shows by category, keyword, or alphabetically.
  - **On-screen help**—The TV Guide On Screen system contains on-screen feature definitions and navigation instructions.

### To open the TV Guide On Screen system:

- While watching TV, press the TV GUIDE button on the remote control; —or—
- Press MENU, open the APPLICATIONS menu, highlight TV GUIDE ON SCREEN, and press ENTER.

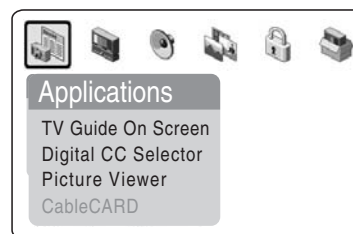

## Setting up the TV Guide On Screen system

Follow these instructions to set up the TV Guide On Screen system so it can receive current program data for your area.

**Note:** If you move the TV to a different ZIP/postal code, you will need to perform the TV GUIDE ON SCREEN SETUP process to reconfigure your TV Guide On Screen system.

**If you have not already connected your antenna, cable box, and/or recording device, see Chapter 2 for connection instructions.**

**Note:** You must connect a VCR or an IEEE-1394 compatible recording device to use the TV Guide On Screen system's one-touch recording feature. It is recommended that you connect your devices according to the connection instructions in Chapter 2.

The unauthorized recording, use, distribution, or revision of television programs, videotapes, DVDs, and other materials is prohibited under the Copyright Laws of the United States and other countries, and may subject you to civil and criminal liability.

1. Press MENU and open the SETUP menu.
2. Highlight INSTALLATION and then press ENTER to open the INSTALLATION menus. (A new set of menu icons will appear on-screen, as shown in step 4 below.)
3. Open the TV GUIDE ON SCREEN SETUP menu, highlight START, and then press ENTER.

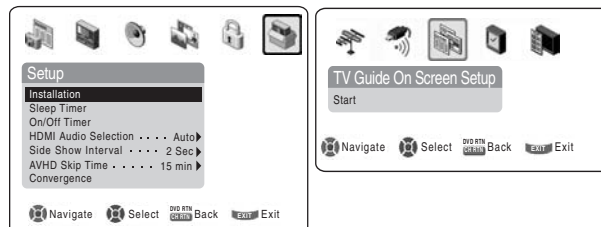

4. Go to Chapter 3 for instructions on completing the setup. Read this chapter for details on using the TV Guide On Screen interactive program guide.

## Navigating the TV Guide On Screen system

- While watching TV, press the TV GUIDE button to enter the TV Guide On Screen system. The LISTINGS screen will appear with the current show highlighted.
- When in the TV Guide On Screen system, if you press the TV GUIDE button from any screen, the TV will tune to the show displayed in the Video Window.
- Use the arrow keys on the remote control (▲▼◀▶) to highlight any show, and then press ENTER to tune to that show.
- Scroll left or right (◀▶) to view eight days of listings.
- Press MENU to display a panel menu with options for the currently highlighted program or tile, including setting recordings and reminders.
- To access another Service screen:
  1. Press ▲ to highlight the Service Bar.
  2. Press ◀ or ▶ to highlight a different Service (LISTINGS, SEARCH, SETUP, SCHEDULE, or RECORDINGS).
  3. Press ▼ to use that Service.

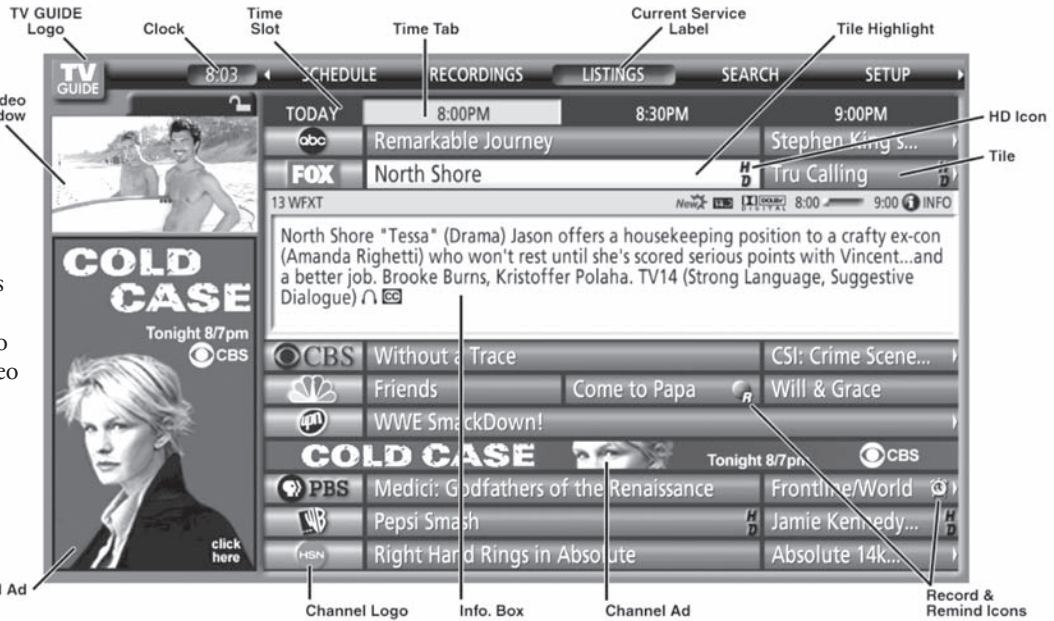

**Note:**

- The TV Guide On Screen menus shown in this manual are for illustration purposes only. The channels, programs, and TV Guide On Screen information as illustrated may not be available in your area. The options and features as illustrated are subject to change when updates are downloaded from the TV Guide On Screen service to your TV.
- The TV Guide On Screen interactive program guide supports cable-ready, cable box, and digital cable services, as well as over-the-air broadcasts. It does not provide listings for satellite services.

**Note:** Helpful information about each Service appears in the Info Box.

## TV Guide On Screen remote control functions

BUTTON	FUNCTION
TV GUIDE	<ul style="list-style-type: none"> <li>• When watching TV, enters the TV Guide On Screen system and highlights the current show listing.</li> <li>• When in the TV Guide On Screen system, returns to watching TV and displays the show in the Video Window.</li> </ul>
Numbers	• For direct channel tuning, priority ordering, and channel editing.
- (digital separator)	• For entering digital channel numbers.
MENU	• Displays the panel menu, in which you can choose options (for example, record, remind, keyword).
INFO	• Cycles between levels of information, as available, in a Service screen or other type of screen.
ENTER	<ul style="list-style-type: none"> <li>• Makes a selection or executes an action.</li> <li>• With a currently airing show listing highlighted, returns to watching TV and tunes to the show channel.</li> <li>• With a future airing show listing highlighted, displays a panel menu with viewing options.</li> </ul>
▲▼◀▶	<ul style="list-style-type: none"> <li>• Provide directional control.</li> <li>• When watching TV, ▲ and ▼ provide surfing through channels turned ON in the LISTINGS screen.</li> </ul>
PAGE UP/DOWN	• When in the TV Guide On Screen system, moves from one set of screen information to the next, when applicable.
REC	• When in the TV Guide On Screen system or watching TV, initiates the recording process.
SPLIT	• When in the TV Guide On Screen system, toggles between locking and unlocking the Video Window.
▶▶ and ◀◀	• Jump forward and backward one day in the LISTINGS screen.

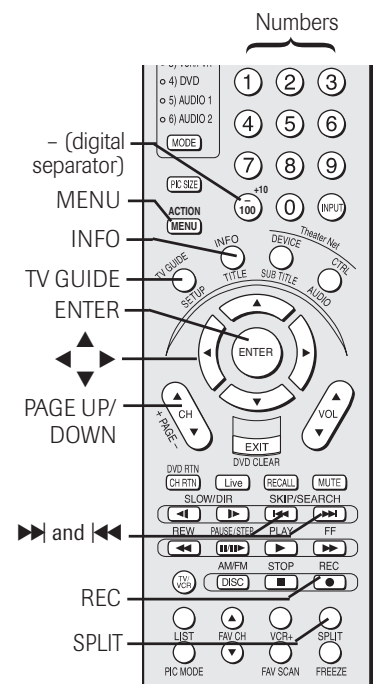

## Navigating the TV Guide On Screen system (continued)

### Video Window

- When you open the TV Guide On Screen system, the current program appears in the Video Window.
- As you scroll through the listings, the Video Window will change to display the selected program.

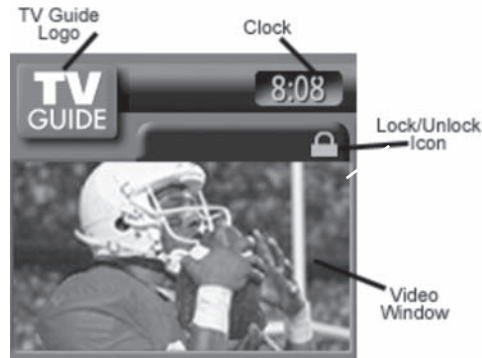

- The lock/unlock icon indicates the status of the Video Window.
- You can set the Video Window to remain on a single channel (locked) or to change channels (unlocked) as you navigate through listings.

#### To lock/unlock the Video Window:

Press the SPLIT button on the remote control to toggle between locking and unlocking the Video Window.

—or—

Highlight a channel logo or the LISTINGS Service Bar Label and press MENU to display the option to lock/unlock the Video Window.

### Panel Menus

- A panel menu appears:
  - when you press MENU on a highlighted tile (if additional options are available); or
  - when you press ENTER on a show starting in the future.
  - when you press VCR+ while watching TV (when the TV Guide On Screen is not open).
- When a panel menu appears, the highlighted tile changes color to indicate that the panel menu relates to the tile.
- Press **INFO** to display help for the current panel menu.
- Press **▲** and **▼** to move among the options.
- Press **◀** and **▶** to move to adjacent options or, if the highlight is on a odometer, to change the odometer choice.
- To move the highlight to the default command button, press ENTER from an odometer or entry box.
- To execute the action and close the panel menu, highlight the command button and press ENTER.
- To cancel any changes and close the panel menu:
  - press MENU; or
  - highlight Cancel and press ENTER.
- If a panel menu contains more options than can be displayed in one panel, the word “more” appears at the bottom of the menu. To access the additional options, either scroll down using the **▼** button or the PAGE UP/DOWN (CH **▲▼**) button.

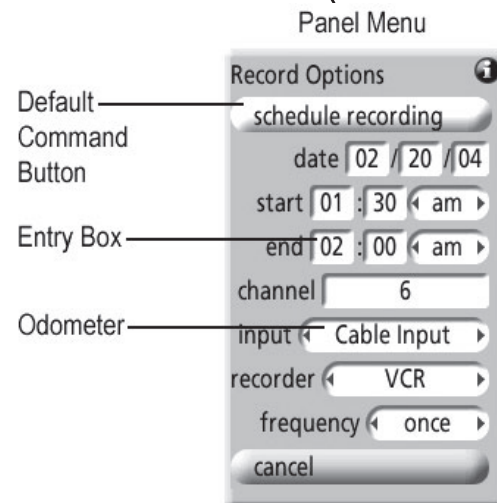



## Navigating the TV Guide On Screen system (continued)

### Info Box

- An Info Box contains information about a show, Service, or Panel Ad, or provides general help (for example, for a panel menu).
- An Info Box for a program in the LISTINGS screen can have up to three sizes: Small, Large, or “No.”
  - Press INFO on the remote control to cycle among the sizes.
  - The default Info Box size is Small. To change the default size, open the SETUP Service screen.
- The Info Button icon (  INFO ) appears on the Info Action Bar if the Info Box size can change and/or if there are additional Info screens. Press the INFO key on the remote control to change the size and/or to display additional Info screens.
- In some instances, the INFO button on the remote control is used to page forward (for example, if there are additional pages of information in a Panel Ad, a Channel Ad, or help text).



Info Action Bar

















Small Info Box



Large Info Box

### TV Guide On Screen Icons

ICON	NAME	DESCRIPTION
	Info Button	• Additional Info Box information is available, or the Info Box has additional sizes.
	Progress Bar	• Elapsed time in current show. • Progress bar appears in LISTINGS and SEARCH and when the Info Button is pressed while watching TV.
	HDTV	• Show is presented in high-definition TV, if available.
	New	• Show is new (not a repeat).
	Stereo	• Show is available in stereo.
	Dolby Digital	• Show is available with Dolby Digital 5.1 audio (digital channels only).
	CC	• Closed captioning is available for the show.
	TV Rating	• TV rating for the show.
	Record Once	• Show is set to Record Once. • Other frequencies are Daily (manual recording only), Regularly, and Weekly.
	Record Off	• Show is set to Record but is currently Off (show remains in Schedule).
	Record Suspended	• Show is Suspended due to a schedule conflict (show remains in Schedule). • Recording resumes when the conflict no longer exists.
	Remind Once	• Show is set to Remind Once. • Other frequencies are Daily (manual reminding only), Regularly, and Weekly.
	Remind Off	• Show is set to Remind but is currently Off (show remains in Schedule).
	Remind Suspended	• Show is Suspended due to a schedule conflict (show remains in Schedule). • Remind resumes when the conflict no longer exists.





## TV Guide On Screen Services

The TV Guide On Screen system consists of five main services: LISTINGS, SEARCH, RECORDINGS, SCHEDULE, and SETUP.

**Note:** For the RECORDINGS service to display, an IEEE-1394 recording device must be connected to the television (see Chapter 2); otherwise, only four services display. Recording to other devices, such as a VCR, are possible from within the LISTINGS service.

### LISTINGS screen

- When you open the TV Guide On Screen system, LISTINGS is always the first service displayed.



- With LISTINGS highlighted in the Service Bar, press INFO to display a help screen. Press INFO again to close the screen.

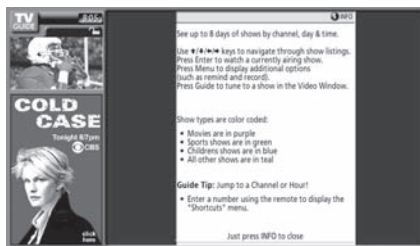

- Use the arrow keys to move the highlight within LISTINGS to do the following:
  - View eight days of show listings
  - Read show descriptions



- Tune directly to a show currently airing
- Set a show to Remind (e.g., start time, frequency, automatic power ON, auto-tune TV)
- Set a show to Record (e.g. start/end time, frequency)
- Lock and unlock the Video Window
- Access panel ads and channel ads

- Use the Number keys on the remote control to jump to a specific channel's listings.
- To watch a show (if on now), highlight the show and press ENTER.
- To display the Episode Options panel menu for a particular show, highlight a show and press MENU.



### Episode Options panel menu

From the Episode Options panel menu, you can choose to set a recording, set a reminder, or tune to the channel. The following are descriptions of the buttons.

**GO TO SERVICE BAR:** Closes the menu, changes no information, and returns to the Service Bar.

**TUNE TO CHANNEL / WATCH NOW:** Exits the TV Guide On Screen system and tunes to the channel of the highlighted show (if the show airs in the future) or tunes to the show (if the show is currently airing). The button label changes according to whether the show is currently airing or not.

**SET RECORDING:** Displays the Record Options panel menu, from which you can set the show to record. For additional information, see "RECORDINGS screen" on page 60, "SCHEDULE screen" and "Record features" on page 61, and "Remind features" on page 63.

**SET REMINDER:** Displays the Remind Options panel menu, from which you can set a reminder for the show. For additional information, see "SCHEDULE screen" and "Record features" on page 61, and "Remind features" on page 63.

**CANCEL:** Closes the menu, changes no information, and returns to the highlighted show.

## TV Guide On Screen Services (continued)

### SEARCH screen

- SEARCH allows you to find shows by keyword or category (alphabetical, HDTV, movies, sports, children, educational, news, variety, series).



- With SEARCH highlighted in the Service Bar, press INFO to display a help screen. Press INFO again to close the screen.



- Use the arrow keys to move the highlight within SEARCH.

### Example: Category search

- From the SEARCH screen, press ▼ to highlight a category (in this example, MOVIES).



- Press ▼ to highlight a subcategory (in this example, ALL).



- Press ENTER to display a list of all movies, organized by date and time.



- Highlight a show and press ENTER to watch (if on now) or press MENU to display the Episode Options panel menu. (See "Episode Options panel menu" on page 57.)



## TV Guide On Screen Services (continued)

### SEARCH screen (continued)

#### Example: Keyword search

Keyword search lets you enter a word(s) to find a particular show by category or for every show title that matches.

1. From the SEARCH screen, highlight KEYWORD, and then press ENTER.
2. Highlight NEW SEARCH in the panel menu, and then press ENTER.



3. The Search Options panel menu opens. Highlight CATEGORY, and then use the arrow keys to highlight a category to search (All, HDTV, Children, Sports, etc.).
4. After highlighting a category, press ▼ to highlight ENTER KEYWORD, and then press ENTER.



5. The keyboard is displayed. Use the arrow keys to highlight a character and then press ENTER to display it. When finished entering all characters, highlight DONE and press ENTER.



6. A list of all matching shows for that keyword is displayed.



7. Highlight a show and press ENTER to display all airings. Then highlight a specific listing and press ENTER to watch (if on now) or press MENU to display the Episode Options panel menu. From the Episode Options menu, you can choose to set a recording or reminder, or tune to the channel (see "Episode Options panel menu" on page 57.)



The TV Guide On Screen system stores all the keywords you create.

#### To edit or delete a keyword:

From the SEARCH/KEYWORD screen, highlight the keyword you want to edit or delete, and then press MENU to display the Search Options panel menu, with the following options:

- GO TO SERVICE BAR: Closes the menu, changes no information, and returns to the Service Bar.
- EDIT SEARCH: Displays the keyboard, from which you can change the keyword.

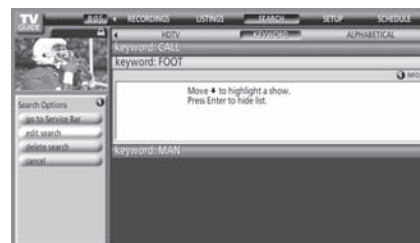

- DELETE SEARCH: Displays the Confirmation panel menu. Select YES to delete the search or NO to close the panel menu.
- CANCEL: Closes the panel menu, changes no information, and returns to the highlighted show.

## TV Guide On Screen Services (continued)

### RECORDINGS screen

The RECORDINGS service screen displays a list of previously recorded or currently recording shows on an IEEE-1394 recording device connected to the TV (see Chapter 2).

**Note:** RECORDINGS will not appear in the Service Bar unless you have an IEEE-1394 video recording device connected to one of the IEEE-1394 ports on the TV. See Chapter 2 for details.

For additional details, see "Record features" on page 61.

- With RECORDINGS highlighted in the Service Bar, press INFO to display a help screen. Press INFO again to close the screen.



#### To choose the way recordings are displayed:

1. Highlight RECORDINGS on the Service Bar, and press MENU to display the Recording Options panel menu.
2. Press ▲▼ to choose between View As and Sort By, as described below.

**View As:** Press ◀▶ to choose between the following:

- **List**—Displays every recorded episode for a show (see example in Screen B, at right).

**Note:** In List view, highlight an episode to display an Info Box with show information. Press MENU to display the Episode Options panel menu (see "Episode Options panel menu" on page 57).

- **Group**—Displays recorded shows without listing every recorded episode (see example in Screen A, at right).

**Note:** In Group view, highlight a show and press ENTER to view a summary of all recorded shows. Press ENTER again to collapse the episode list.



**Sort By:** Press ◀ and ▶ to choose between the following:

- **Title**—Displays recorded shows in alphabetical order (see example in Screen A, at right).
- **Date**—Displays recorded shows by date and time, with most recent first (see example in Screen B, at right).

3. When finished, press ENTER to highlight DONE, and then press ENTER again to close the panel menu and display the recordings with the selected options.

#### To view a recording, you can do one of the following:

- Highlight an episode and press ENTER to view it now. The episode either starts from the beginning or from where it was last stopped (if viewed previously).
- Highlight an episode and press MENU to display the Episode Options panel menu, with the following options:
  - GO TO SERVICE BAR: Closes the menu, changes no information, and returns to the Service Bar.
  - RESUME: Starts from the beginning or from where it was last stopped (if viewed previously).
  - PLAY FROM BEGINNING: Starts from the beginning, even if stopped previously.
  - DELETE EPISODE: Deletes the episode from the RECORDINGS list and deletes the recording from the IEEE-1394 recording device. A Confirm panel menu displays. Press YES to delete the episode or NO to close the panel menu.
  - CANCEL: Closes the panel menu, changes no information, and returns to the highlighted show.

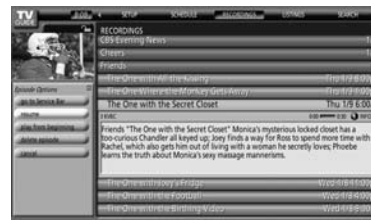

Screen A



Screen B



The unauthorized recording, use, distribution, or revision of television programs, videotapes, DVDs, and other materials is prohibited under the Copyright Laws of the United States and other countries, and may subject you to civil and criminal liability.



## TV Guide On Screen Services (continued)

### SCHEDULE screen

The SCHEDULE service screen allows you to review, edit, or delete Record and Remind events you set previously.



- With SCHEDULE highlighted in the Service Bar, press INFO to display a help screen. Press INFO again to close the screen.



- Highlight an event and press MENU to display the Schedule Options panel menu, with the following options:
  - GO TO SERVICE BAR: Closes the menu, changes no information, and returns to the Service Bar.
  - WATCH NOW: Exits the TV Guide On Screen system and tunes to the highlighted show.
  - DELETE RECORDING: Removes the recording from the schedule. A Confirm panel menu displays. Press YES to delete the recording or NO to close the panel menu.
  - EDIT RECORDING: Opens a menu in which you can change existing recording information.
  - SET REMINDER: Opens a menu in which you can set a reminder for the show (Record is not cancelled).
  - CANCEL: Closes the panel menu, changes no information, and returns to the highlighted show.

An icon identifies the event type. For more details, see “Record features,” at right, and “Remind features” on page 63.



### Record features

You can set a show to Record in LISTINGS, SEARCH, and SCHEDULE, or change Record settings for a show in SCHEDULE. There are three ways to set a show to Record.

#### 1) Set a show to Record using the REC key on the remote control

Press the REC key on the remote control to record the show Once with current default settings (start and end recording on time). Each time you press REC, you change the Record frequency (but not the default settings) among Once (default), Regularly, Weekly, and Cancel.

**Note:** The related Record icon appears on the show tile each time you press REC. See “Record icons,” below.

#### 2) Set a show to Record from a panel menu

1. Highlight a show and press MENU to display the Episode Options panel menu.
2. Highlight SET RECORDING and press ENTER to display the Record Options panel menu.



3. Highlight the FREQUENCY field, and press ◀ or ▶ to choose among Once, Regularly, Weekly, or Off.
4. Highlight the START field, and press ◀ or ▶ to choose in the range from 120 minutes early to 120 minutes late or On Time (default = On Time).
5. Repeat step 4 for the END field.
6. Highlight the RECORDER field and press ◀ or ▶ to choose the recording device.
 

**Note:** For connected IEEE-1394 recording devices only.
7. Highlight the KEEP UNTIL field and press ◀ or ▶ to choose how long you want to keep the Record event.
 

**Note:** For connected IEEE-1394 recording devices only.
8. Press ENTER to highlight SCHEDULE RECORDING, and press ENTER again to close the menu.

A Record icon for the selected frequency appears on the show tile. See “Record Icons” on page 62.

**Note:** For connected IEEE-1394 recording devices only.

Or highlight CANCEL and press ENTER to close the menu, change no information, and return to the highlighted show.

**Note:** You can change the default values of the Record Options panel menu fields. See “Change default options” on page 66.



## TV Guide On Screen Services (continued)

### Record features (continued)

#### 3) Manually set a show to Record

1. Highlight SCHEDULE in the Service Bar, and press MENU to display the Schedule Options panel menu.  
Press ▲▼◀▶ to move through the options.  
Press the Number keys or ▲▼◀▶ to change the information, as necessary.
2. Highlight NEW MANUAL RECORDING and press ENTER to display the Record Options panel menu.
3. Enter the information in the panel menu fields. For details, see “Set a show to Record from a panel menu” on the previous page.  
**Note:** When setting a Manual Recording, the option “Daily” is available instead of “Regularly.” See “Record icons,” below right, for a description of Record icons.
4. When finished entering the information in the fields, press ENTER to highlight SCHEDULE RECORDING, and press ENTER again to close the menu.  
A Record icon for the selected frequency appears on the show tile. See “Record Icons,” below right.

**Note:** Manual recording is listed by channel number.

Or highlight CANCEL and press ENTER to close the menu, change no information, and return to the highlighted show.

#### Recording notification banner

- If the TV is not on, the recording occurs as scheduled.
- If the TV is on, a notification banner appears on-screen before recording starts. At that time you can choose to start or cancel recording.

If no choice is made within 3 minutes, the notification banner closes automatically and completes the highlighted item (“change channel; start recording” is the default highlighted item).



The unauthorized recording, use, distribution, or revision of television programs, videotapes, DVDs, and other materials is prohibited under the Copyright Laws of the United States and other countries, and may subject you to civil and criminal liability.

#### Record conflict

A conflict message appears for the following reasons:

- A show set to Record overlaps with any part of another show previously set to Record.
- A show set to Record overlaps with a show previously set to auto-tune. (For auto-tune details, see “Remind features” on page 63.)

Select one of these options:

- Record Anyway—This show will override an existing show set to Record or auto-tune.
- Don't Record This Show—Cancels the Recording.



#### Record icons

Following is a description of the Record icons that will appear on the tile for a show set to Record.

- Record Once —Records the show one time.
- Record Regularly —Records the show every time the show airs on the same channel and starts at the same time.
- Record Weekly —Records the show every time the show airs on the same day of the week and on the same channel, and starts at the same time.
- Record Daily —Records the show every weekday (Monday through Friday) that the show airs on the same channel and starts at the same time.

**Note:** This icon displays for manual recordings only.

- Record Suspend —Show is Suspended due to a schedule conflict (show remains in Schedule).
- Record Off —Keeps the show in the list but will not record this show until the frequency is changed.

## TV Guide On Screen Services (continued)

### Remind features

You can set a Reminder to perform the following functions:

- Automatically turn on the TV (if off) at the scheduled reminder time, and tune the TV to the channel of the show for which you set the reminder.
- Automatically tune the TV, at the scheduled reminder time, to the channel of the show for which you set the reminder.
- Display an on-screen notification banner (reminding you that the show is about to start), from which you can choose to tune the TV to the show's channel or cancel the reminder.

You can set a show reminder in LISTINGS, SEARCH, and SCHEDULE, or change the settings for a show reminder in SCHEDULE. There are two ways to set a show reminder.

#### 1) Set a show Reminder from a panel menu

1. Highlight a show and press MENU to display the Episode Options panel menu.
2. Highlight SET REMINDER and press ENTER to display the Remind Options panel menu.



3. Highlight the FREQUENCY field, and press ◀ or ▶ to choose among Once, Regularly, Weekly (or Daily, if setting a Manual Reminder), or Off.
4. Highlight the POWER ON TV field, and press ◀ or ▶ to choose either Yes (to turn on the TV automatically, if off, at the scheduled Reminder time) or No (default).
5. Highlight the AUTO TUNE TV field, and press ◀ or ▶ to choose either Yes (to automatically tune the TV to the channel you are setting the Reminder for at the scheduled Reminder time; the TV must be on at the time) or No (default).
 

**Note:** You can change the default values of the Remind Options panel menu fields. See "Change default options" on page 66 for details.
6. Highlight the WHEN field (to set a time for displaying the reminder screen), and press ◀ or ▶ to choose in the range from 15 minutes early to 15 minutes late or On Time (default = 1 minute early).
7. Press ENTER to highlight SCHEDULE REMINDER, and press ENTER again to close the menu. A Remind

icon for the selected frequency appears on the show tile. See "Remind Icons" on page 64.

Or highlight CANCEL and press ENTER to close the menu, change no information, and return to the highlighted show.

#### 2) Manually set a show Reminder

1. Highlight SCHEDULE in the Service Bar, and press MENU to display the Schedule Options panel menu. Press ▲▼◀▶ to move through the options. Press the Number keys or ▲▼◀▶ to change the information, as necessary.
2. Highlight NEW MANUAL REMINDER and press ENTER to display the Remind Options panel menu.



3. Enter the information in the panel menu fields. For details, see "Set a show reminder from a panel menu," at left.

**Note:** When setting a Manual Reminder, the option "Daily" is available instead of "Regularly." See "Remind icons," on the following page, for a description of Reminder icons.

4. When finished entering the information in the fields, press ENTER to highlight SCHEDULE REMINDER, and press ENTER again to close the menu.

A Remind icon for the selected frequency appears on the show tile. See "Record Icons" on the following page.

**Note:** Manual reminders are listed by channel number.

Or highlight CANCEL and press ENTER to close the menu, change no information, and return to the highlighted show.

## TV Guide On Screen Services (continued)

### Remind features (continued)

#### Reminder notification banner

Based on your option settings, a notification banner will appear on-screen, if your TV is on at the scheduled Reminder time.

At that time you can either press ENTER to hide the Reminder banner, or highlight the show and press ENTER to tune to the show.

If no choice is made within 3 minutes, the notification banner closes automatically and completes the highlighted item (default is HIDE REMINDERS).

**Note:** If more than two reminders are set for the same time, arrows appear on the Reminder notification banner. Press ▲▼ to highlight the shows.



#### Remind conflict

A conflict message appears for the following reasons:

- A show set with an auto-tune Reminder has the same start time as an existing auto-tune Reminder.
- A show set with an auto-tune Reminder overlaps with a scheduled Recording.

Select one of these options:

- Auto-Tune Anyway—This show will override an existing show set to auto-tune.
- Proceed, No Auto-Tune—Set the show as a Reminder but do not auto-tune.
- Don't Set This Reminder—Cancels the Reminder.

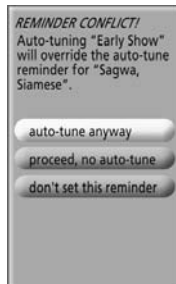

#### Remind icons

Following is a description of the Remind icons that will appear on the tile for a show set to Remind.

- Remind Once —Displays a show reminder one time.
- Remind Regularly —Displays a show reminder every time the show airs on the same channel and starts at the same time.
- Remind Daily —Displays a show Reminder every weekday (Monday through Friday) that the show airs on the same channel and starts at the same time.

**Note:** This icon displays for manual reminders only.

- Remind Suspend —Show is Suspended due to a schedule conflict (show remains in Schedule).
- Remind Off —Keeps the show in the list but will not display a reminder until you change the frequency.

## TV Guide On Screen Services (continued)

### SETUP screen

After you complete the initial TV Guide On Screen setup (as described in Chapter 5), you can change the following settings:

- Change system settings
- Change channel display
- Change default options

Highlight a choice, press ENTER, and follow the on-screen instructions.



With SETUP highlighted in the Service Bar, press INFO to display a help screen. Press INFO again to close the screen.

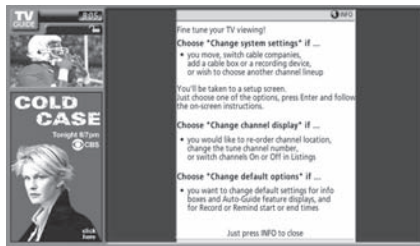

### Change system settings

This option appears only after you have completed the initial TV Guide On Screen setup process (as described in Chapter 5).

1. From the SETUP screen, highlight CHANGE SYSTEM SETTINGS and press ENTER.

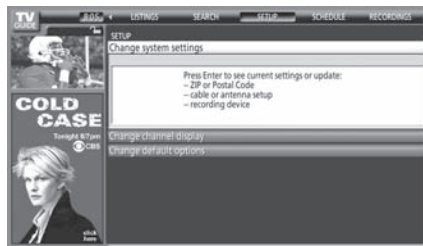

2. Press ENTER again to display the Confirming Your Settings screen.
3. Highlight one of the options, press ENTER, and follow the on-screen instructions.

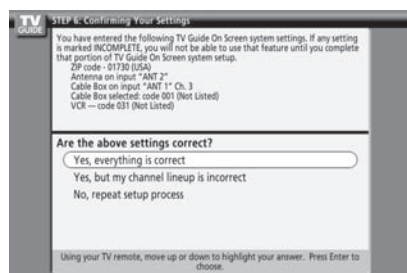

### Change channel display

This option allows you to edit channel information that appears in LISTINGS, including the following:

- Reorder the position the channels appear in LISTINGS.
- Change the “tune channel” number.

**Note:** The “tune channel” is the channel on which you receive a station. For example, two viewers in the same zip code may receive the same station on different channel numbers, depending on whether they have Cable service or are using a cable box.

- Switch a channel to one of the following settings:
  - **On** (channel is always displayed in LISTINGS)
  - **Off** (channel is never displayed in LISTINGS)
  - **Auto-Hide** (channel is displayed in LISTINGS only when program information is available)

1. From the SETUP screen, highlight CHANGE CHANNEL DISPLAY and press ENTER.

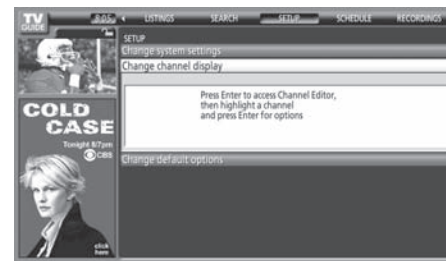

2. Press ENTER again to display the Grid Options panel menu.



3. Highlight one of the options, press ENTER, and follow the on-screen instructions.

## TV Guide On Screen Services (continued)

### SETUP screen (continued)

#### Change default options

This option allows you to change default settings in the following categories:

- General Default Options
- Record Defaults
- Remind Defaults

#### General default options

1. From the SETUP screen, highlight CHANGE DEFAULT OPTIONS and press ENTER.

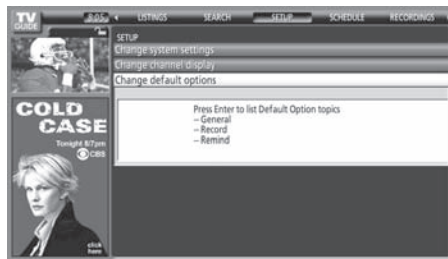

2. Highlight GENERAL DEFAULT OPTIONS and press MENU to display the General Default Options panel menu.



3. Enter the following information in the panel menu fields:
  - **BOX SIZE:** The initial Info Box size when you open the TV Guide On Screen system. Choices are No, Small (default), Large, and Last Used.
  - **BOX CYCLE:** The Info Box size rotation when you press INFO on the remote control when the TV Guide On Screen system is open. Choices are No Only, Small Only, Large Only, No & Small, No & Large, Small & Large, and All (default).
  - **AUTO GUIDE:** Automatic entry into the TV Guide On Screen system when the TV is powered on. Choices are On (default) and Off.

**Note:** Set the AUTO GUIDE to Off if you do not want the TV Guide On Screen system to open every time you turn on the TV.

4. When finished, press ENTER to highlight DONE, and press ENTER again to close the menu and accept the changes (or highlight CANCEL to close the menu with no changes).

#### Record defaults

1. From the SETUP screen, highlight CHANGE DEFAULT OPTIONS and press ENTER.
2. Highlight RECORD DEFAULTS and press MENU to display the Record Defaults panel menu.



3. Enter the required information in the panel menu fields (start time, end time, recorder choice, how long to keep a Record event, the quality of the recording). See “Record features” on page 61 for details on entering values in these fields.
4. When finished, press ENTER to highlight DONE, and press ENTER again to close the menu and accept the changes (or highlight CANCEL to close the menu with no changes).

#### Remind defaults

1. From the SETUP screen, highlight CHANGE DEFAULT OPTIONS and press ENTER.
2. Highlight REMIND DEFAULTS and press MENU to display the Remind Defaults panel menu.



3. Enter the required information in the panel menu fields (power On TV, auto-tune, when to display the Remind screen). See “Remind features” on page 63 for details on entering values in these fields.
4. When finished, press ENTER to highlight DONE, and press ENTER again to close the menu and accept the changes (or highlight CANCEL to close the menu with no changes).



## 8 Using the TV's features

### Selecting the video input source to view

#### To select the video input source to view:

1. Press INPUT on the remote control or TV/VIDEO on the TV front panel.
2. Press 0–7 to select the input source you want to view, depending on which input jacks you used for connecting your devices (see Chapter 2).

The current signal source displays in the top right corner of the INPUT SELECTION screen.

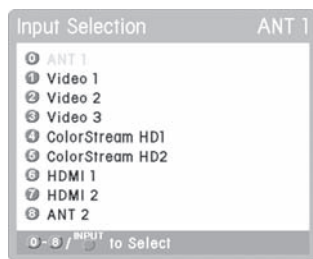

#### Note:

- While the Input Selection screen is open, you also can use the ▲▼ buttons on the remote control (or the Channel ▲▼ buttons on the front panel) to change the input.
- While the Input Selection screen is **not** open, you can repeatedly press the INPUT button on the remote control or the TV/VIDEO button on the TV front panel to change the input.
- To select an IEEE-1394 input source, press the TheaterNet DEVICE button on the remote control (see page 44).
- If an IEEE-1394 device is the current input, it will appear at the bottom of the Input Selection list; however, it will be removed from the list if the input source is changed.
- You can label the video input sources according to the specific devices you have connected to the TV (see next page).
- The source can be "hidden." See page 68 for details.
- If you use the TV's remote control to start recording, you will not be able to change inputs during recording. If you use a device other than the TV's remote control to start recording and then change inputs, the recorded audio and video may be affected.

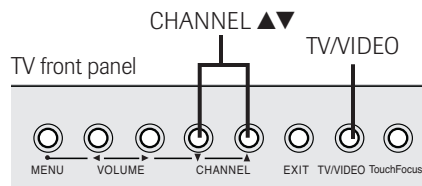
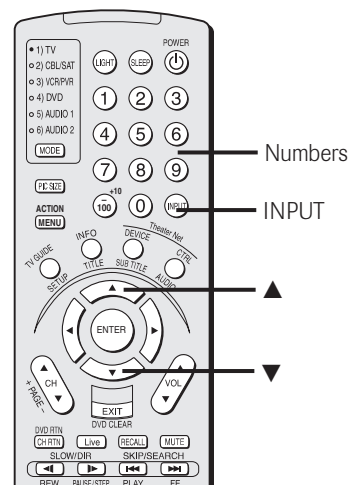

## Labeling the video input sources

You can label each video input source according to the type of device you connected to each source, from the following preset list of labels:

- (default label)
- Hide (to hide an unused input in the Input Selection window)
- Audio Receiver
- VCR
- Video Recorder
- Laser Disk
- Compact Disc
- DVD
- DTV
- SAT (satellite box)
- CBL (cable box)
- HD (high definition device)
- PVR (personal video recorder)

**Note:**

- If you set up devices in TheaterNet™, the associated inputs are automatically labeled and cannot be relabeled until you remove the device from TheaterNet (see page 44).
- If you set up a cable box in VIDEO 1, it will automatically be labeled and cannot be relabeled until you remove the device from the TV Guide On Screen setup.
- You cannot select IEEE-1394 devices through the INPUT SELECTION window; however, you can select and control IEEE-1394 devices through TheaterNet (see page 44).

**To label the video input sources:**

1. Press MENU and open the PREFERENCES menu.
2. Highlight INPUT LABELING and press ENTER.

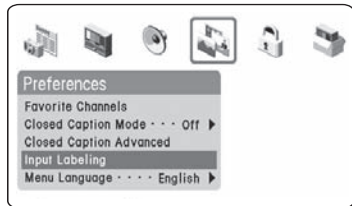

3. Press ▼ or ▲ to highlight the video source you want to label.
4. Press ◀ or ▶ to select the desired label for that input source. If a particular input is not used, you can select "HIDDEN" as the label, which will cause that input to be "grayed out" in the input list and skipped over when you press the INPUT button on the remote control.
5. To save the labels, highlight SAVE and press ENTER.

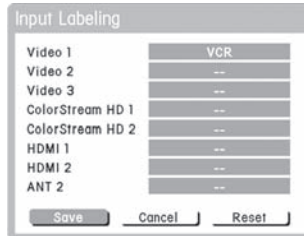

**Note:**

If you select "HIDDEN" for all of the input labels, the POP feature will be disabled. If you attempt to access the POP feature, a red "NOT AVAILABLE" will display at the bottom of the screen.

**Input labeling example:**

If you connect a VCR to VIDEO 1, a DVD player to ColorStream HD-1, and a high definition satellite receiver to HDMI, and then label the video input sources accordingly (as shown in step 4 at left), when you press INPUT or TV/VIDEO, the INPUT SELECTION screen would look like the screen below right:

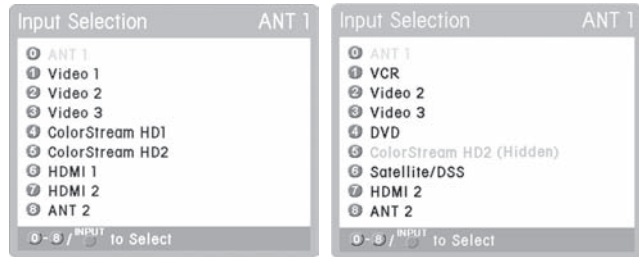

Input Selection screen with no inputs labeled

Input Selection screen with inputs 1, 4, and 6 labeled, and input 5 hidden.

**To clear the input labels:**

1. Press MENU and open the PREFERENCES menu.
2. Highlight INPUT LABELING and press ENTER.
3. Highlight RESET and press ENTER.
4. Highlight SAVE and press ENTER.

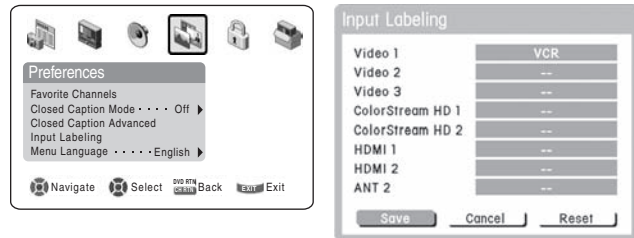

**Note:** Labels for devices you set up in TheaterNet will not be cleared until you remove the device from TheaterNet (see page 44). The screen above right illustrates an example of the Input Labeling screen after it was reset that still shows the VCR label for VIDEO 1 because the VCR was set up in TheaterNet.

## Tuning channels

### Tuning to the next programmed channel

**To tune to the next programmed channel:**

Press CHANNEL ▲ or ▼ on the remote control or TV front panel.

**Note:**

- This feature will not work unless you program channels into the TV's channel memory (see page 41).
- If you use the TV's remote control to start recording, you will not be able to change the channel during recording. If you use a device other than the TV's remote control to start recording and then change the channel, the recorded audio and video will be that of the currently tuned channel.

### Using SpeedSurf to change to a specific programmed channel

**Note:** This feature will not work unless you program channels into the TV's channel memory (see page 41).

1. Press and hold CHANNEL ▲ or ▼ for a few seconds. The TV will enter SpeedSurf mode.

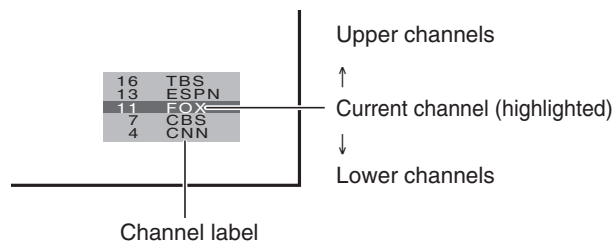

2. Repeatedly press or hold CHANNEL ▲ or ▼ while the SpeedSurf mode is on-screen to scroll through the channel list. Release the button to display the highlighted channel.

### Tuning to a specific channel (programmed or unprogrammed)

**Tuning analog channels:**

Press the Channel Number buttons (0–9) on the remote control. For example, to select channel 125, press 1, 2, 5.

**Tuning digital channels:**

Press the Channel Number buttons (0–9) on the remote control, followed by the – (dash) button and then the sub-channel number.

For example, to select digital channel 125-1, press 1, 2, 5, –, 1.

**Note:** If a digital channel is not programmed—either through the automatic channel scan (page 41) or the channel add/delete function (page 42)—you will have to tune the RF channel using the Channel Number and Dash buttons on the remote control.

### Switching between two channels using Channel Return

The Channel Return feature allows you to switch between two channels without entering an actual channel number each time.

1. Select the first channel you want to view.
2. Select a second channel using the Channel Number buttons (and the dash (–) button if selecting a digital channel).
3. Press CH RTN on the remote control. The previous channel will display.

Each time you press CH RTN, the TV will switch back and forth between the last two channels that were selected.

**Note:** If you press CH RTN from a non-antenna input, the TV will return to the last-viewed ANT input and channel.

### Switching between two channels using SurfLock™

The SurfLock™ feature temporarily “memorizes” one channel in the CH RTN button, so you can return to that channel quickly from any other channel by pressing CH RTN.

To memorize a channel in the CH RTN button:

1. Select the channel you want to program into the CH RTN button.
2. Press and hold CH RTN for about 2 seconds until the message “Channel Memorized” appears on the screen. The channel has been programmed into the CH RTN button.
3. Continue to change channels until your desired channel is selected.
4. Press CH RTN. The memorized channel will be selected.

The TV will return to the memorized channel one time only. Once you press CH RTN and then change channels again, the CH RTN button memory will be cleared and the button will function as Channel Return, by switching back and forth between the last two channels that were selected.

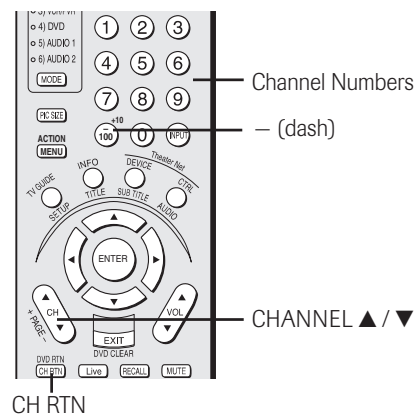

## Selecting the picture size

You can view many program formats in a variety of picture sizes—Natural, TheaterWide® 1, TheaterWide® 2, TheaterWide® 3, and Full—as described below and on the next page.

The way the image displays in any of the picture sizes will vary depending on the format of the program you are viewing. Select the picture size that displays the current program the way that looks best to you. *See “Notice of possible adverse effects on TV picture tube,” below right.*

### To select the picture size:

1. Press PIC SIZE on the remote control.
2. While the Picture Size menu is on-screen, press the corresponding number button (0–4) to select the desired picture size.

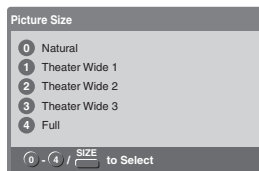

#### Note:

- You also can repeatedly press PIC SIZE to select the desired picture size (or press the ▲▼ buttons on the remote control while the Picture Size screen is open).
- “Full” may not be available for some program formats (will be “grayed out” in the Picture Size screen).

### Natural picture size

- The image is displayed close to its originally formatted proportion. Some program formats will display with side bars and/or bars at the top and bottom.

Natural picture size example: The way the image displays will vary depending on the format of the program you are currently watching. See “Notice of possible adverse effects on TV picture tube” at right.

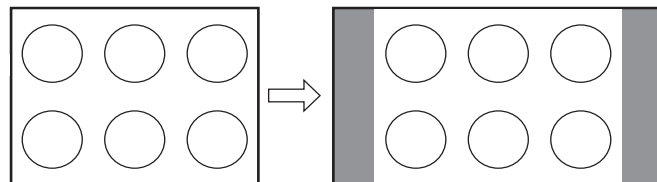

Conventional picture on a conventional TV screen

Conventional picture in Natural size on your wide-screen TV

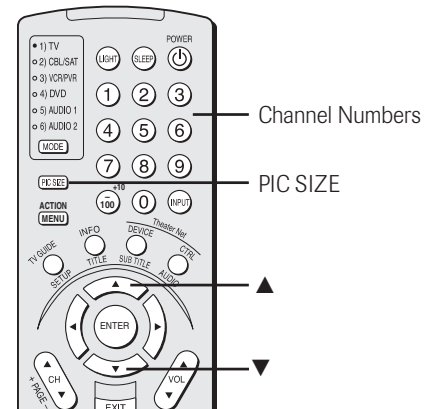

### NOTICE OF POSSIBLE ADVERSE EFFECTS ON TV PICTURE TUBE

Avoid displaying stationary images on your TV screen for extended periods of time. Fixed (non-moving) images (such as still PIP/POP windows, black/gray bars in wide-screen or PIP/POP formats, stock tickers, video game patterns, TV station logos, closed captions, and websites) can become permanently engrained in the picture tube. **This type of damage is NOT COVERED BY YOUR WARRANTY.**

## Selecting the picture size (continued)

### TheaterWide® 1 picture size (For 4:3 format program)

- The center of the picture remains close to its original proportion, but the left and right edges are stretched wider to fill the screen.

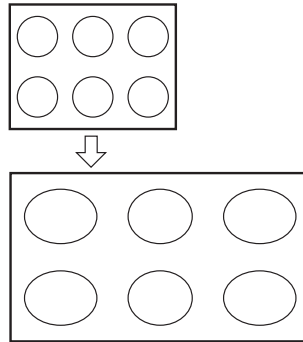

Theater Wide 1 picture size example

### TheaterWide® 2 picture size (for letter box programs)

- The picture is stretched wider to fill the width of the screen, but only slightly stretched taller.
- The top and bottom edges of the picture are hidden. To view the hidden areas, see "Scrolling the Theater Wide picture" on page 72.

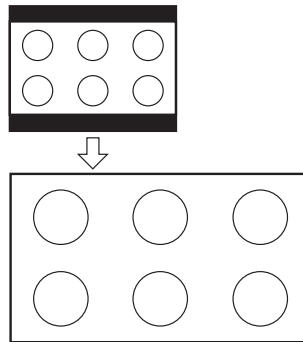

Theater Wide 2 picture size example

### TheaterWide® 3 picture size (for letter box programs with subtitles)

- The picture is stretched wider to fill the width of the screen, but only slightly stretched taller.
- The top and bottom edges are hidden. To view the hidden areas (such as subtitles or captions), see "Scrolling the TheaterWide picture" on page 72.

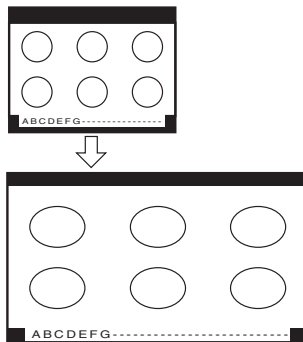

Theater Wide 3 picture size example

### Full picture size (for 16:9 [480i, 480p] source programs only)

- If receiving a 4:3 format program, it is stretched wider to fill the width of the screen, but not stretched taller.
- None of the picture is hidden.

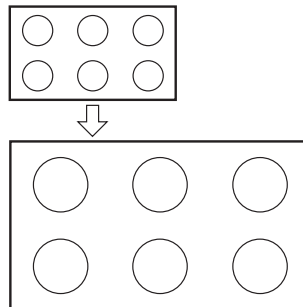

Full picture size example

To select the picture size, press PIC SIZE on the remote control.

You also can select the picture size using the menu system. Select PICTURE SIZE in the VIDEO / THEATER SETTINGS menu.

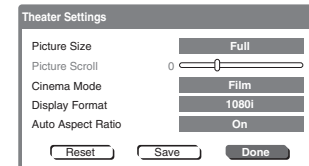

#### Note:

- If you select one of the TheaterWide picture sizes, the top and bottom edges of the picture (including subtitles or captions) may be hidden. To view the hidden edges, either scroll the picture (TheaterWide 2 and 3 only) or try viewing the program in Full or Natural picture size.
- When selecting the picture size, the way the image displays will vary depending on the format of the program you are currently watching. See "Notice of possible adverse effects on TV picture tube" below.

#### NOTICE OF POSSIBLE ADVERSE EFFECTS ON TV PICTURE TUBE

Avoid displaying stationary images on your TV screen for extended periods of time. Fixed (non-moving) images (such as still PIP/POP windows, black/gray bars in wide-screen or PIP/POP formats, stock tickers, video game patterns, TV station logos, closed captions, and websites) can become permanently engrained in the picture tube. **This type of damage is NOT COVERED BY YOUR WARRANTY.**

Using the special functions to change the size of the displayed image (i.e. changing the height/width ratio) for the purpose of public display or commercial gain may infringe on copyright laws.



## Scrolling the TheaterWide® picture (TheaterWide 2 and 3 only)

You can set separate scroll settings for TheaterWide 2 and TheaterWide 3 modes.

### To set the scroll settings:

1. Press MENU and open the VIDEO menu.
2. Highlight THEATER SETTINGS and press ENTER.

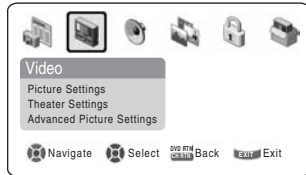

3. In the PICTURE SIZE field, select either TheaterWide 2 or TheaterWide 3 (you cannot scroll in any other mode).
4. Press ▼ to highlight the PICTURE SCROLL field.
5. Press ◀ or ▶ to scroll the picture up and down as needed, from -10 to +20.

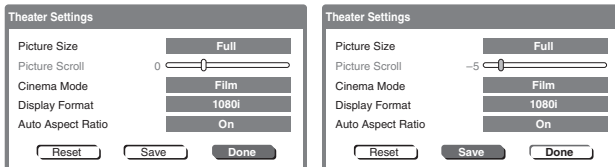

6. To save your scroll settings temporarily, highlight DONE and press ENTER.  
To save your scroll settings permanently, highlight SAVE and press ENTER.

## Using the auto aspect ratio feature

When the AUTO ASPECT feature is set to ON and one of the following input sources is received, the picture size is automatically selected (as described in the table below):

- A 480i signal from the VIDEO 1, VIDEO 2, VIDEO 3, ColorStream HD-1, or ColorStream HD-2 input.
- A 480i or 480p signal from the HDMI input.

Aspect ratio of signal source	Automatic aspect size (automatically selected when AUTO ASPECT is ON)
4:3 normal	Natural (with side bars)
4:3 letter box	TheaterWide 2
16:9 full	Full
Not defined (no ID-1 data or ) HDMI aspect data)	User-selected picture size (see pages 64-65)

### Note:

- The AUTO ASPECT feature is not applicable to antenna or Cable input sources.
- The AUTO ASPECT feature is not available when the POP double-window is open, the FREEZE mode is active, or the TV Guide On Screen system is open.

### To turn on the AUTO ASPECT feature:

1. Press MENU and open the VIDEO menu.
2. Highlight THEATER SETTINGS and press ENTER.

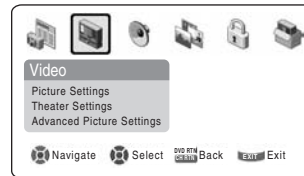

3. In the AUTO ASPECT RATIO field, select ON.
4. To save your settings temporarily, highlight DONE and press ENTER.

To save your settings permanently, highlight SAVE and press ENTER.

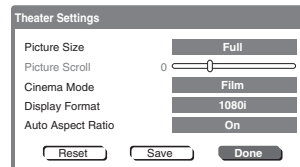

### To turn off the AUTO ASPECT feature:

Select OFF in step 3 above.

## Selecting the cinema mode (480i signals only)

When you view a DVD (480i signal; 3:2 pulldown processed) from a DVD player connected to the ColorStream HD1/HD2 (component video) or HDMI inputs on the TV, smoother motion can be obtained by setting the CINEMA MODE to FILM.

### To set the CINEMA MODE to FILM:

1. Press MENU and open the VIDEO menu.
2. Highlight THEATER SETTINGS and press ENTER.

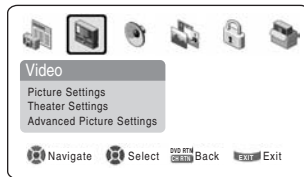

3. In the CINEMA MODE field, select FILM.

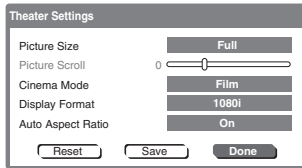

4. To save your settings temporarily, highlight DONE and press ENTER.  
To save your settings permanently, highlight SAVE and press ENTER.

### To set the CINEMA MODE to VIDEO:

Select VIDEO in step 3 above.

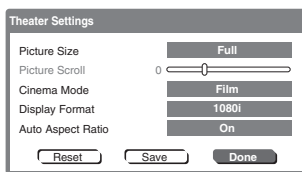

## Selecting the display format (480i and 480p signals only)

You can use this feature to convert a 480p input signal to 540p or 1080i.

### To select the display format:

1. Press MENU and open the VIDEO menu.
2. Highlight THEATER SETTINGS and press ENTER.

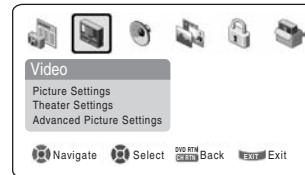

3. In the DISPLAY FORMAT field, select either 540p or 1080i.

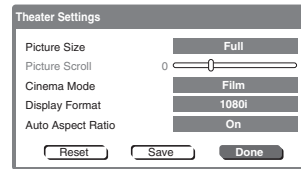

4. To save your settings temporarily, highlight DONE and press ENTER.  
To save your settings permanently, highlight SAVE and press ENTER.

### Note:

- Input signals other than 480i or 480p are automatically converted to 1080i.
- If you notice flicker in a 480p image, try setting the DISPLAY FORMAT to 540p.

## Using the POP features

### Using the POP double-window feature

The POP (picture-out-picture) double-window feature splits the screen into two windows so you can watch two programs at the same time.

#### To display a program in the POP window:

1. Select the program you want to watch in the main window.
2. Press SPLIT to open the POP window.

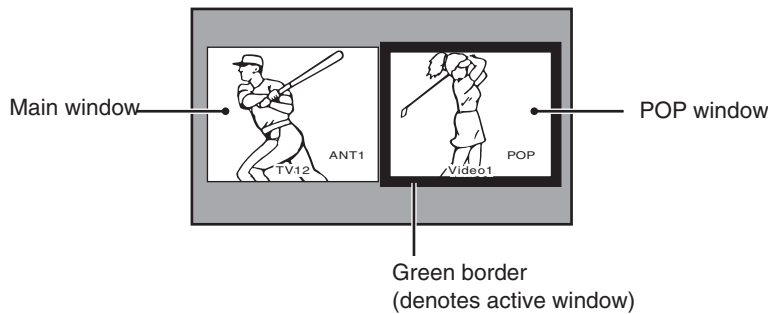

3. Press **▶** to highlight the POP window (will have a green border).
4. Press **INPUT** to open the Pop Input Selection window. Select the input source for the POP window by pressing the corresponding Number button (0–7). The current source displays in purple in the Pop Input Selection window.

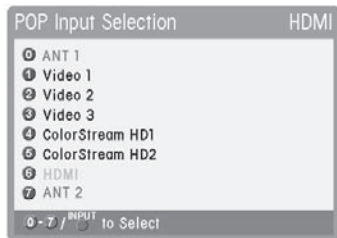

#### To close the POP window and tune to the currently highlighted window:

Press **ENTER** after highlighting the window you want to view as a normal picture.

#### To close the POP window:

Press **SPLIT** or **EXIT**.

#### Notes about recording:

- When the POP window is open and you start recording, the POP window will close and recording will start.
- If you use the TV's remote control to start recording, you will not be able to open the POP window. If you attempt to do so, the message "Not Available" will appear on-screen.
- It is recommended that you use the TV's remote control to start recording. If you use a device other than the TV's remote control to start recording, you may be able to open the POP window during the recording process. If this happens, the recorded audio will reflect the audio of the active window (main or POP), which may not be the audio you intended to record.

#### Note:

- When the main window is in the ANT1 or ANT2 mode, the ANT1 and ANT2 inputs cannot be selected for the POP window.
- When the main window is in Video 1/2/3, ColorStream HD1/HD2, or HDMI mode, those inputs cannot be selected for the POP window.
- You cannot view IEEE-1394 source programs in the POP window.
- You cannot view two video or two antenna sources in both the main and POP windows simultaneously. (You can view a video source in one window and an antenna source in the other.)

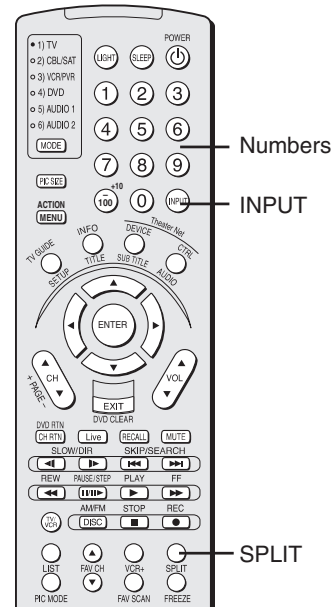

#### NOTICE OF POSSIBLE ADVERSE EFFECTS ON TV PICTURE TUBE

Avoid displaying stationary images on your TV screen for extended periods of time. Fixed (non-moving) images (such as still PIP/POP windows, black/gray bars in wide-screen or PIP/POP formats, stock tickers, video game patterns, TV station logos, closed captions, and websites) can become permanently engrained in the picture tube. **This type of damage is NOT COVERED BY YOUR WARRANTY.**

## Using the POP features (continued)

### Switching the speaker audio (main or POP)

While the POP window is open, press ◀ or ▶ to switch the sound (main or POP) that is output from the TV speakers (and from the VARIABLE AUDIO OUT and AUDIO OUT jacks).

The window with the active sound is outlined with a green border.

Example: Press ◀

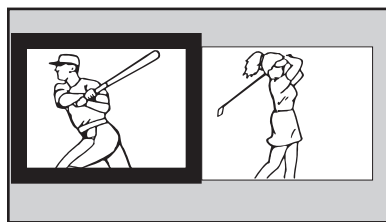

Example: Press ▶

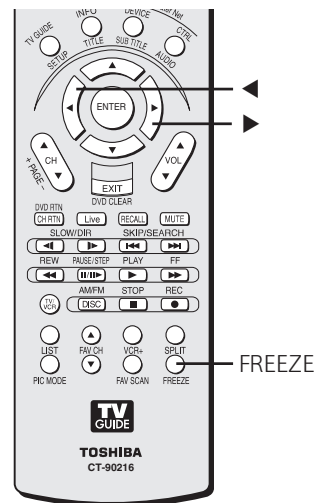
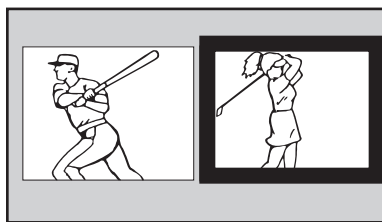

### Freezing the main picture in the POP double-window

1. While the POP double-window is *not* open, press FREEZE. The POP window will open, displaying the main picture as a still picture.
2. Continue to press FREEZE repeatedly to refresh the still picture in the POP window, which acts as a slow "strobe" of the program in the main window.

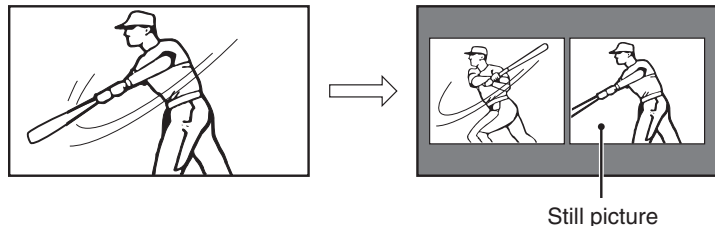

**To close the still POP window:**

Press EXIT.

**Note:** The FREEZE feature is not available when the POP window is already open. If you press FREEZE when the POP window is open, the message "Not available" will appear.

#### NOTICE OF POSSIBLE ADVERSE EFFECTS ON TV PICTURE TUBE

Avoid displaying stationary images on your TV screen for extended periods of time. Fixed (non-moving) images (such as still PIP/POP windows, black/gray bars in wide-screen or PIP/POP formats, stock tickers, video game patterns, TV station logos, closed captions, and websites) can become permanently engrained in the picture tube. **This type of damage is NOT COVERED BY YOUR WARRANTY.**

## Using the POP features (continued)

### POP double-window aspect ratio

The POP double-window feature displays each picture according to its input signal aspect ratio, as illustrated below.

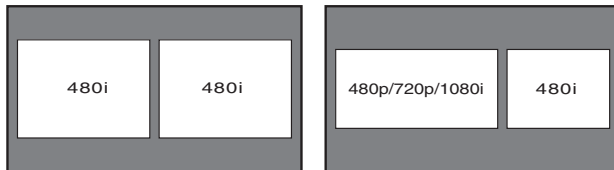

**Note:**

The AUTO ASPECT RATIO feature (page 72) does not operate in POP double-window mode.

### Using the favorite channel scan feature

You can use this feature to quickly scan and tune the channels you programmed as favorite channels in a nine-picture multi-window.

**Note:** The favorite channel scan feature will not work unless you program channels into the favorite channel memory (see "Programming your favorite channels" on page 43).

**To scan and tune your favorite channels:**

1. Press FAV SCAN. The TV automatically enters multi-window mode and begins a nine-picture scan of your favorite channels for the current ANT input.

To view your favorite channels for the other antenna input, you will need to change antenna inputs first (page 67), and then press FAV SCAN.

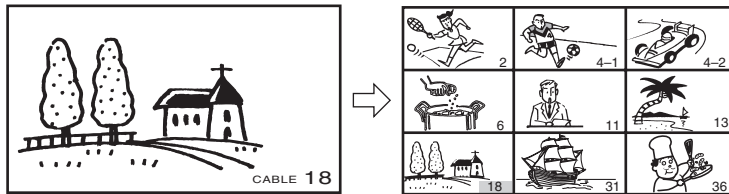

2. Press ▲▼◀▶ to select one of the nine pictures, which becomes a moving picture (the active window). (The main picture is always moving.)
3. Press ENTER to display the channel you selected in step 2 as the main picture.

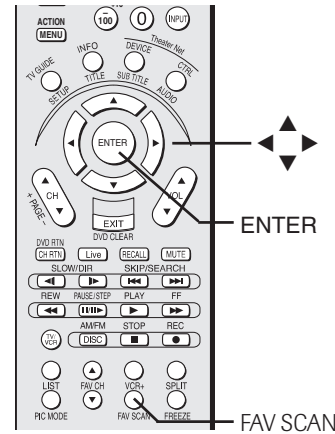
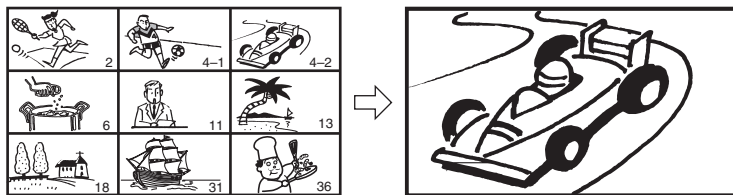

**NOTICE OF POSSIBLE ADVERSE EFFECTS ON TV PICTURE TUBE**

Avoid displaying stationary images on your TV screen for extended periods of time. Fixed (non-moving) images (such as still PIP/POP windows, black/gray bars in wide-screen or PIP/POP formats, stock tickers, video game patterns, TV station logos, closed captions, and websites) can become permanently engrained in the picture tube. **This type of damage is NOT COVERED BY YOUR WARRANTY.**

**Notes about recording:**

- When the FAV SCAN multi-window is open and you try to start recording, the message "Not Available" will appear on-screen. You will not be able to start recording until you close the FAV SCAN multi-window.
- If you use the TV's remote control to start recording, you will not be able to open the FAV SCAN multi-window. If you attempt to do so, the message "Not Available While Recording" will appear on-screen.
- It is recommended that you use the TV's remote control to start recording. If you use a device other than the TV's remote control to start recording, you may be able to open the FAV SCAN multi-window during the recording process. If this happens, the recorded audio and video will reflect the audio and video of the active window, which may not be what you intended to record.



## Adjusting the picture

### Selecting the picture mode

You can select your desired picture settings from four picture modes, as described below.

Mode	Picture Quality
Sports	Bright and dynamic picture (factory setting)
Standard	Standard picture settings (factory setting)
Movie	Lower contrast for darkened room (factory setting)
Preference	Your personal preferences

#### To select the picture mode:

Press PIC MODE on the remote control. The following popup menu appears on-screen.



Repeatedly press PIC MODE to cycle among the modes.

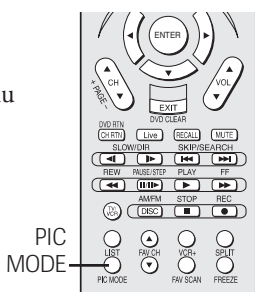

#### To select the picture mode using the menu system:

1. Press MENU and open the VIDEO menu.
2. Highlight PICTURE SETTINGS and press ENTER.

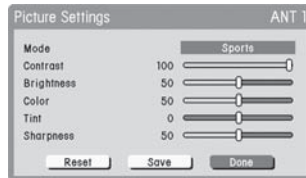
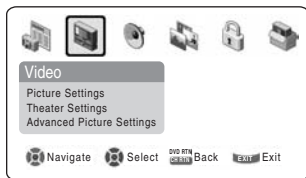

3. Press ▼ to highlight the MODE field, and then ◀▶ to select the mode you prefer.
4. To temporarily save the mode you selected, highlight DONE and press ENTER.

**Note:** Temporarily saved settings will apply until the TV is turned off or the input source is changed.

To permanently save the mode you selected, highlight SAVE and press ENTER.

#### Note:

- The picture mode you selected is for the current input selection only (ANT 1 in the example above). You can select a different picture mode for each input selection.
- If you select one of the factory-set picture modes (SPORTS, STANDARD, or MOVIE) and then change a picture quality setting (for example, increase the contrast or change the color temperature), the picture mode automatically changes to PREFERENCE in the Picture Settings menu.

### Adjusting the picture quality

You can adjust the picture quality (contrast, brightness, color, tint, and sharpness) to your personal preferences.

#### To adjust the picture quality:

1. Press MENU and open the VIDEO menu.
2. Highlight PICTURE SETTINGS and press ENTER.
3. Press ▼ or ▲ to select the picture quality you want to adjust (CONTRAST, BRIGHTNESS, COLOR, TINT, or SHARPNESS), and then ◀ and ▶ to adjust the setting, as described in the table below.

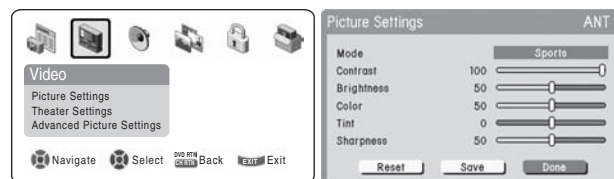

Selection	◀ Pressing ▶
contrast	lower higher
brightness	darker lighter
color	paler deeper
tint	reddish greenish
sharpness	softer sharper

4. To temporarily save the new settings, highlight DONE and press ENTER. To permanently save the new settings, highlight SAVE and press ENTER.

**Note:** The settings you selected are for the current input selection only (ANT 1 in the example above). You can select different settings for each input selection.

The picture qualities you adjusted are automatically saved in the PREFERENCE mode (see “Selecting the picture mode,” above left).

### Resetting the picture settings

#### To reset the picture settings to their factory values:

1. Highlight RESET in the Picture Settings menu and press ENTER.
2. Highlight SAVE and press ENTER.

**Note:** This resets the pictures settings for the current input source only (ANT 1 in this example).

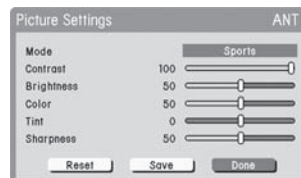

## Adjusting the picture (continued)

### Using the Night Mode feature

The Night Mode feature can be activated to reduce eye strain when the room is dark.

#### To activate the Night Mode:

1. Press MENU and open the VIDEO menu.
2. Highlight ADVANCED PICTURE SETTINGS and press ENTER.
3. Press ▼ to highlight the NIGHT MODE field, and then press ► to select ON.

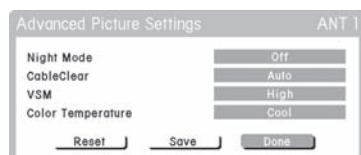
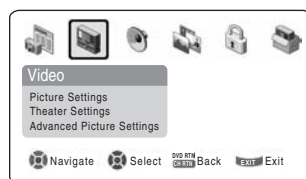

4. To temporarily save the new settings, highlight DONE and press ENTER.

To permanently save the new settings, highlight SAVE and press ENTER.

#### Note:

- When the Night Mode feature is ON, the CONTRAST setting (page 77) is not adjustable.

#### To deactivate the Night mode:

Select OFF in step 3 above.

### Using CableClear™ DNR (digital noise reduction)

The CableClear™ digital noise reduction feature allows you to reduce visible interference in your TV picture. This may be useful when receiving a broadcast with a weak signal (especially a Cable channel) or playing back a video cassette or disc damaged by repeated use.

**NOTE:** The CableClear DNR feature does not function in HDMI (DVI), ATSC, IEEE-1394, and digital Cable modes.

#### To turn on CableClear DNR:

1. Press MENU and open the VIDEO menu.
2. Highlight ADVANCED PICTURE SETTINGS and press ENTER.
3. Press ▼ to highlight the CABLECLEAR DNR field, and then press ► to select AUTO.

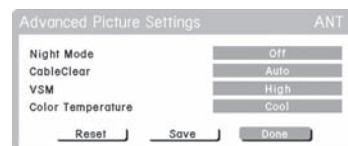
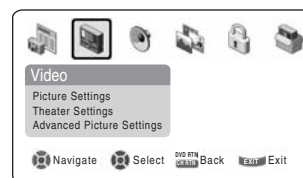

4. To temporarily save the new settings, highlight DONE and press ENTER.

To permanently save the new settings, highlight SAVE and press ENTER.

#### NOTE:

- If the current input is Antenna, Video 1, Video 2, or Video 3, the menu will display the text "CableClear."
- If the current input is ColorStream HD1 or ColorStream HD2, the menu will display the text "DNR."
- If the current input is HDMI or IEEE-1394, the menu will display the text "DNR" and will be "grayed out" to indicate that the feature does not function in this input.

#### To turn off CableClear DNR:

Select OFF in step 3 above.

## Adjusting the picture (continued)

### Selecting the color temperature

You can change the quality of the picture by selecting from three preset color temperatures: cool, medium, and warm, as described below.

Mode	Picture Quality
cool	blueish
medium	neutral
warm	reddish

#### To select the color temperature:

1. Press MENU and open the VIDEO menu.
2. Highlight ADVANCED PICTURE SETTINGS and press ENTER.
3. Press ▼ to highlight the COLOR TEMPERATURE field, and then press ► to select the mode you prefer (COOL, MEDIUM, or WARM).

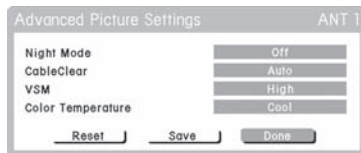
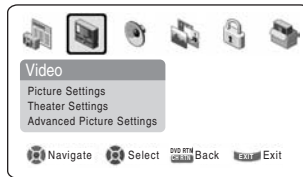

4. To temporarily save the new settings, highlight DONE and press ENTER.  
To permanently save the new settings, highlight SAVE and press ENTER.

### Resetting the advanced picture settings

To reset the advanced picture settings to their factory values:

1. Press MENU and open the VIDEO menu.
2. Highlight ADVANCED PICTURE SETTINGS and press ENTER.

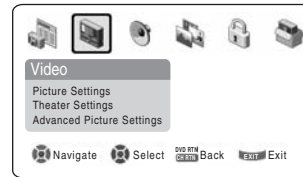

3. Highlight RESET and press ENTER.
4. Highlight SAVE and press ENTER.

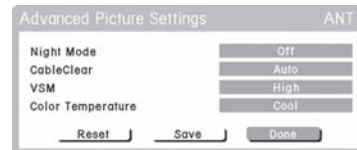

### Adjusting the Velocity Scan Modulation

The velocity scan modulation (VSM) feature enhances picture contrast and sharpness. This feature has three modes: HIGH, LOW, AND OFF.

**NOTE:** VSM is not required when viewing some high-quality video material. If you are watching high-quality video material, you may want to set VSM to OFF.

#### To Adjust the VSM:

1. Press MENU and open the VIDEO menu.
2. Highlight ADVANCED PICTURE SETTINGS and press ENTER.
3. Press ▼ highlight the VSM field, and then press ► to select the mode you prefer (HIGH, LOW, or OFF).
4. To temporarily save the new settings, highlight DONE and press ENTER. To permanently save the new settings, highlight SAVE and press ENTER.

**NOTE:** If you change the mode in the Picture Settings window after changing the VSM, the VSM may be automatically changed to default settings associated with the newly selected mode.

## Using the closed caption mode

The closed caption mode has two options:

- **Captions**—An on-screen display of the dialogue, narration, and sound effects of TV programs and videos that are closed captioned (usually marked “CC” in program guides).
- **Text**—An on-screen display of information not related to the current program, such as weather or stock data (when provided by individual stations).

### To view captions or text:

1. Press MENU and open the PREFERENCES menu.
2. Highlight CLOSED CAPTION MODE and then press ► to open the menu sidebar.
3. Press ▼ to highlight the desired closed caption mode and then press ENTER.

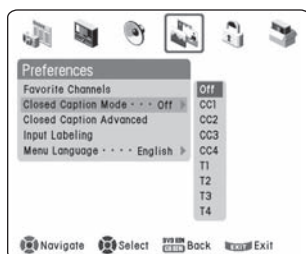

#### To view captions:

Highlight CC1, CC2, CC3, or CC4. (CC1 displays translation of the primary language in your area.)

**Note:** If the program or video you selected is not closed captioned, no captions will display on-screen.



#### To view text:

Highlight T1, T2, T3, or T4.

**Note:** If text is not available in your area, a black rectangle may appear on your screen. If this happens, turn the Closed Caption Mode OFF.

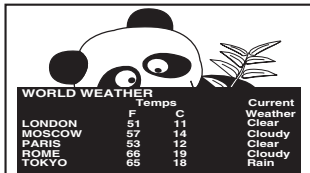

#### To turn off the Closed Caption feature:

Highlight OFF.

**Note:** A closed caption signal may not display in the following situations:

- When a videotape has been dubbed
- When the signal reception is weak
- When the signal reception is non-standard

## Advanced closed captions

You can customize the closed caption display characteristics by changing the background color and the text size, type, edge, and color.

**Note:** This feature is available for digital channels only.

### To customize the closed captions:

1. Press MENU and open the PREFERENCES menu.
2. Highlight CLOSED CAPTION ADVANCED and press ENTER.
3. Press ▼ or ▲ to highlight the characteristic you want to change, and then press ► to select the format for that characteristic.
4. To temporarily save the new settings, highlight CANCEL and press ENTER.

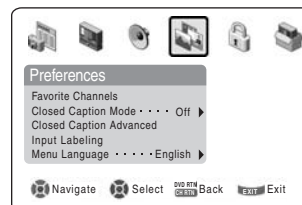

To permanently save the new settings, highlight SAVE and press ENTER.

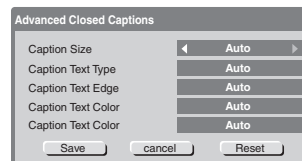

### To reset the closed caption characteristics:

1. Highlight RESET in step 4 above, and press ENTER.
2. Highlight SAVE and press ENTER. All characteristics are set to “AUTO.”

## Digital closed captions

You can use the Digital CC/Audio selector to select digital closed caption services (if available), which will temporarily override closed captions for digital channels only. When such services are not available, the Digital CC/Audio selector presents a default list of services. If the selected service is not available, the next best service will be used instead.

1. Press MENU and open the APPLICATIONS menu.
2. Highlight DIGITAL CC/AUDIO SELECTOR and press ENTER.
3. Press ► or ◀ to highlight the desired service, and then press ENTER.

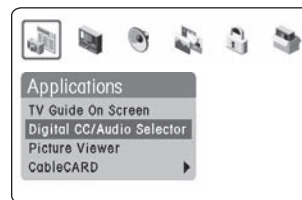

### NOTICE OF POSSIBLE ADVERSE EFFECTS ON TV PICTURE TUBE

Avoid displaying stationary images on your TV screen for extended periods of time. Fixed (non-moving) images (such as still PIP/POP windows, black/gray bars in wide-screen or PIP/POP formats, stock tickers, video game patterns, TV station logos, closed captions, and websites) can become permanently engrained in the picture tube. **This type of damage is NOT COVERED BY YOUR WARRANTY.**

## Adjusting the audio

### Muting the sound

Press MUTE to partially reduce (1/2 MUTE) or turn off (MUTE) the sound. Each time you press MUTE, the mute mode will change in the following order.

→ Normal → 1/2 MUTE → MUTE →

If the closed caption mode is set to OFF when you select "MUTE" mode, the closed caption feature is automatically activated. To mute the audio without automatically activating the closed caption feature, use the VOL ▼ button to set the volume to 0. See "Using the closed caption mode" on page 80 for more information on closed caption modes.

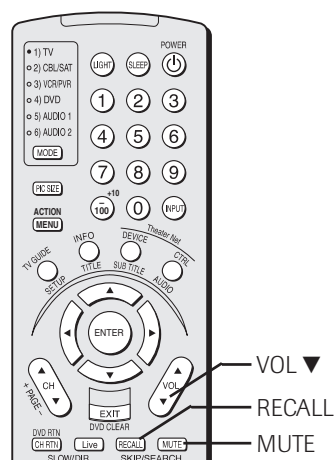

### Digital audio selector

You can use the Digital CC/Audio selector to conveniently switch between audio tracks on a digital channel (for those channels that have multiple audio tracks). This temporarily overrides the audio track chosen by the language option under Audio Setup.

1. Press MENU and open the APPLICATIONS menu.
2. Highlight DIGITAL CC/AUDIO SELECTOR and press ENTER.
3. Press ► or ◀ to highlight the desired service, and then press ENTER.

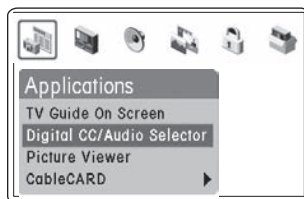

### Selecting stereo/SAP broadcasts

The multi-channel TV sound (MTS) feature allows you to output high-fidelity stereo sound from your TV's speakers. MTS also can transmit a second audio program (SAP) containing a second language, music, or other audio information (when provided by individual stations).

The MTS feature is not available when the TV is in VIDEO mode.

When the TV receives a stereo or SAP broadcast, the word "STEREO" or "SAP" appears on-screen when RECALL is pressed.

#### To listen to stereo sound:

1. Press MENU and open the AUDIO menu.
2. Highlight AUDIO SETUP and press ENTER.
3. Press ▼ to highlight the MTS field, and then press ► to select STEREO.

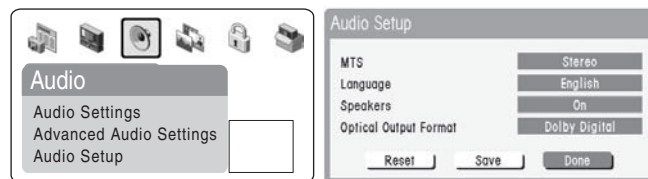

4. To temporarily save the new settings, highlight DONE and press ENTER. To permanently save the new settings, highlight SAVE and press ENTER.

#### Note:

- You can leave the TV in STEREO mode because it automatically outputs the type of sound being broadcast (stereo or monaural).
- If the stereo sound is noisy, select MONO to reduce the noise.

#### To listen to an alternate language on an ATSC digital station (if available):

Highlight the LANGUAGE field in step 3 above, and then press ► to select the language you prefer.

#### To listen to a second audio program on an analog station (if available):

Select SAP in step 3 above.

#### Note:

- A second audio program (SAP) can be heard only on those TV stations that offer it. For example, a station might broadcast another language as a second audio program. If you have SAP on, you will see the current program on the screen but hear the other language instead of the program's normal audio.
- If you have SAP on and the station you are watching is not broadcasting a second audio program, the station's normal audio will be output. However, occasionally there is no sound at all in SAP mode. If this happens, set the MTS feature to STEREO mode.



## Adjusting the audio (continued)

### Adjusting the audio quality

You can adjust the audio quality by adjusting the bass, treble, and balance.

#### To adjust the audio quality:

1. Press MENU and open the AUDIO menu.
2. Highlight AUDIO SETTINGS and press ENTER.

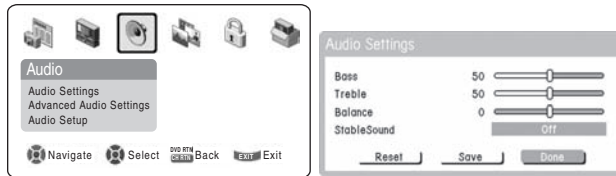

3. Press ▼ to highlight the item you want to adjust (BASS, TREBLE, or BALANCE).
4. Press ◀ or ▶ to adjust the level.
  - ◀ makes the bass or treble weaker or increases the balance in the left channel (depending on the item selected).
  - ▶ makes the bass or treble stronger or increases the balance in the right channel (depending on the item selected).
5. To temporarily save the new settings, highlight DONE and press ENTER. To permanently save the new settings, highlight SAVE and press ENTER.

#### To reset the audio quality to the factory settings:

Highlight RESET in step 5 above, and press ENTER.

The bass and treble are reset to 50 and the balance is reset to 0.

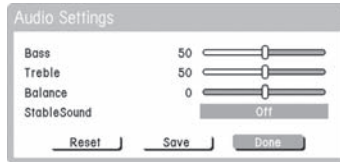

### Using the StableSound® feature

The StableSound® feature limits the highest volume level to prevent extreme changes in volume when the signal source changes (for example, to prevent the sudden increase in volume that often happens when a TV program switches to a commercial).

#### To turn on the StableSound® feature:

1. Press MENU and open the AUDIO menu.
2. Highlight AUDIO SETTINGS and press ENTER.
3. Press ▼ to highlight STABLE SOUND, and then press ▶ to select ON.

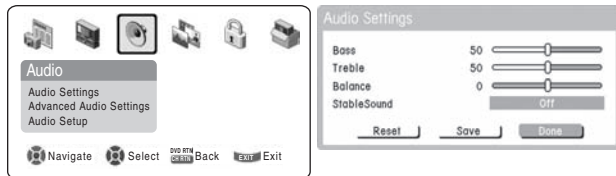

4. To temporarily save the new settings, highlight DONE and press ENTER. To permanently save the new settings, highlight SAVE and press ENTER.

#### To turn off the StableSound feature:

Select OFF in step 3 above.

### Resetting your audio adjustments

The RESET function returns your audio adjustments to the following factory settings:

Bass ..... center (50)  
 Treble ..... center (50)  
 Balance ..... center (0)  
 StableSound... OFF

#### To reset your audio adjustments:

1. Press MENU and open the AUDIO menu.
2. Highlight AUDIO SETTINGS and press ENTER.
3. Press ▼ to highlight RESET and press ENTER.



4. To temporarily save the new settings, highlight DONE and press ENTER. To permanently save the new settings, highlight SAVE and press ENTER.

### Turning off the built-in speakers

Use this feature to turn off the TV speakers when you connect an audio system to your TV (see “Connecting a digital audio system” and “Connecting an analog audio system” on page 20).

#### To turn off the built-in speakers:

1. Press MENU and open the AUDIO menu.
2. Highlight AUDIO SETUP and press ENTER.



3. Press ▼ to highlight the SPEAKERS field, and then press ▶ to select OFF.
4. To temporarily save the new settings, highlight DONE and press ENTER. To permanently save the new settings, highlight SAVE and press ENTER.

#### To turn on the built-in speakers:

Select ON in step 3 above.

## Adjusting the audio (continued)

### Using the SRS WOW™ surround sound feature

WOW is a special combination of SRS Labs audio technologies (SRS 3D, FOCUS, and TruBass) that creates a thrilling surround sound experience with deep, rich bass from stereo sound sources. Your TV's audio will sound fuller, richer, and wider.

#### To adjust the WOW settings:

1. Put the TV in STEREO mode (see "Selecting stereo/SAP broadcasts" on page 81).
2. Press MENU and open the AUDIO menu.
3. Highlight ADVANCED AUDIO SETTINGS and press ENTER.

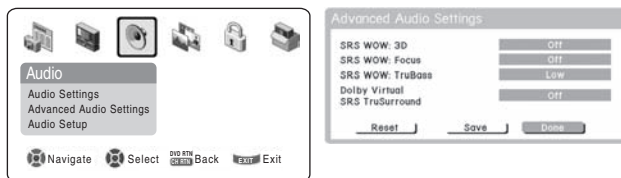

4. Press ▼ or ▲ to highlight the WOW feature you want to adjust, and then press ◀ or ▶ to adjust the item.
  - 3D — To turn the surround sound effect on or off.
 

**Note:** If the broadcast is monaural, the 3D effect does not work.
  - Focus — To turn the vocal emphasis effect on or off.
  - TruBass — To select the desired bass expansion level (HIGH, LOW, or OFF).
5. To temporarily save the new settings, highlight DONE and press ENTER. To permanently save the new settings, highlight SAVE and press ENTER.

#### To reset the WOW settings:

Highlight RESET in the Advanced Audio Settings menu and press ENTER.

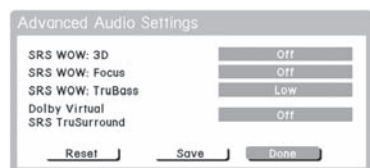

Manufactured under license from Dolby Laboratories. Dolby, Virtual Dolby Digital, and the double-D symbol are registered trademarks of Dolby Laboratories.

SRS WOW, SRS, and the  logo are trademarks of SRS Labs, Inc. SRS WOW technology is incorporated under license from SRS Labs, Inc.

### Using the Dolby Virtual® with SRS TruSurround™ sound feature

The Dolby Virtual with SRS TruSurround sound feature allows you to enjoy virtual surround sound from the TV's speakers.

- For digital input sources (digital antenna/cable or IEEE-1394) encoded with 5.1-channel sound, the Dolby Virtual with SRS TruSurround feature functions as Virtual Dolby Digital, which simulates Dolby Digital 5.1-channel, six-speaker surround sound from the TV's speakers.
- For stereo analog input sources or sources with less than 4-channel coding, the Dolby Virtual with SRS TruSurround feature functions as Virtual Dolby Surround, which simulates Dolby Surround sound from the TV's speakers.

#### To turn on Dolby Virtual with SRS TruSurround:

1. Press MENU and open the AUDIO menu.
2. Highlight ADVANCED AUDIO SETTINGS and press ENTER.
3. Press ▼ to highlight DOLBY VIRTUAL SRS TRUSURROUND, and then press ▶ to select ON.
4. To temporarily save the new settings, highlight DONE and press ENTER. To permanently save the new settings, highlight SAVE and press ENTER.

#### To turn off Dolby Virtual with SRS TruSurround:

Select OFF in step 3 above.

**Note:** The Dolby Virtual SRS TruSurround and SRS WOW 3D features cannot be on at the same time. If you set one to ON, the other will automatically be set to OFF.

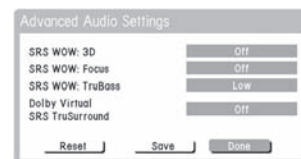

### Selecting the optical audio output format

Use this feature to select the optical audio output format when you connect a Dolby Digital decoder or other digital audio system to the OPTICAL AUDIO OUT jack on the TV (see "Connecting a digital audio system" on page 20).

#### To select the optical audio output format:

1. Press MENU and open the AUDIO menu.
2. Highlight AUDIO SETUP and press ENTER.
3. Press ▼ to highlight the OPTICAL OUTPUT FORMAT field, and then press ▶ to select either DOLBY DIGITAL or PCM, depending on your device.

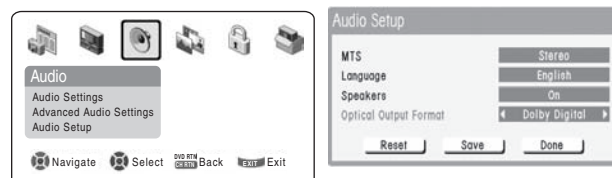

4. To temporarily save the new settings, highlight DONE and press ENTER. To permanently save the new settings, highlight SAVE and press ENTER.

## Using the memory card picture viewer

You can use the picture viewer to view compatible JPEG files from a memory card (see “Memory card specifications” at right). You can display your files in thumbnail mode or view them as a slide show.

**Note:**

- **Never remove the memory card or turn off the TV while using the memory card.** Doing so may result in loss of data or damage to the memory card or TV. **SUCH DAMAGE IS NOT COVERED BY YOUR TOSHIBA WARRANTY.**
- It is recommended that you back up your memory card data. Toshiba is not liable for any damage caused by the use of any memory card with this TV. Toshiba will not compensate for any lost data or recording(s) caused by the use of such cards.
- For instructions on using your digital camera, refer to the owner's manual for your camera.
- For instructions on using your memory card, refer to the owner's manual for your memory card.
- Failure to take proper care of a memory card may prevent display of pictures from the card or result in damage to the memory card or TV. **SUCH DAMAGE IS NOT COVERED BY YOUR TOSHIBA WARRANTY.** See “Memory card care and handling” on page 86.

### NOTICE OF POSSIBLE ADVERSE EFFECTS ON TV PICTURE TUBE

Avoid displaying stationary images on your TV screen for extended periods of time. Fixed (non-moving) images can become permanently engrained in the picture tube. **This type of damage is NOT COVERED BY YOUR WARRANTY.** See item 33 on page 4.

## Memory card specifications

■ Supported memory card types:

- **SmartMedia™** (3.3V) memory card
- SD (Secure Digital™) memory card (ver. 1.0)
- MMC (MultiMediaCard™)
- Memory Stick™ (Pro)
- CompactFlash® memory card (Type 1)

**Note:** The picture viewer supports FAT16 formatted cards only. (Memory cards formatted as FAT32 or NTFS, for example, are not supported.)

■ Maximum memory card capacity: 256 MB.

■ Maximum displayable image size: 8 MB.

**Note:** Files larger than 8 MB will not display.

■ Maximum displayable image resolution: 6000x4000 pixels.

■ Maximum number of files per directory: 370.

**Note:**

- All files over the 370th in a single directory will not display.
- The picture viewer will not display images from memory card directories that are more than 10 levels down from the top level directory.

■ Maximum number of files per memory card: 1,000.

**Note:** All files over the 1,000th on a single memory card will not display.

■ Compression method: JPEG compliant.

**Note:**

- The picture viewer supports JPEG format images only.
- The files on your memory card must be in a file and directory format compatible with the TV or they will not display on the TV.
- Images processed and/or edited on a personal computer (PC) may not display properly or at all. Some digital cameras may store images in a format that is not compatible with the TV; however, you may be able to change the settings on your camera or use a computer to change the format or directory structure of your files so the images will display.

(Continued on next page)

**SmartMedia** is a registered trademark of Toshiba Corporation.

SD (Secure Digital) memory card is a trademark of Matsushita Electric Industry, Toshiba Corporation, and SanDisk Corporation.

MMC and MultiMediaCard are trademarks of Infineon Technologies AG and licensed to MMCA (MultiMediaCard Association).

Memory Stick is a trademark of Sony Corporation.

Toshiba is an authorized licensee of the CompactFlash® and CF logo® registered trademarks.

## Using the memory card picture viewer (continued)

### Viewing digital photos on your TV

1. Insert a memory card into the appropriate memory card slot on the front of your TV. **Do not insert more than one memory card at one time. Be sure to insert the card correctly**—label side up and the end with the notched corner (if applicable) inserted into the memory card slot.

**Note:** When a Compact Flash memory card is inserted correctly, the ejector button pops out (see illustration below).

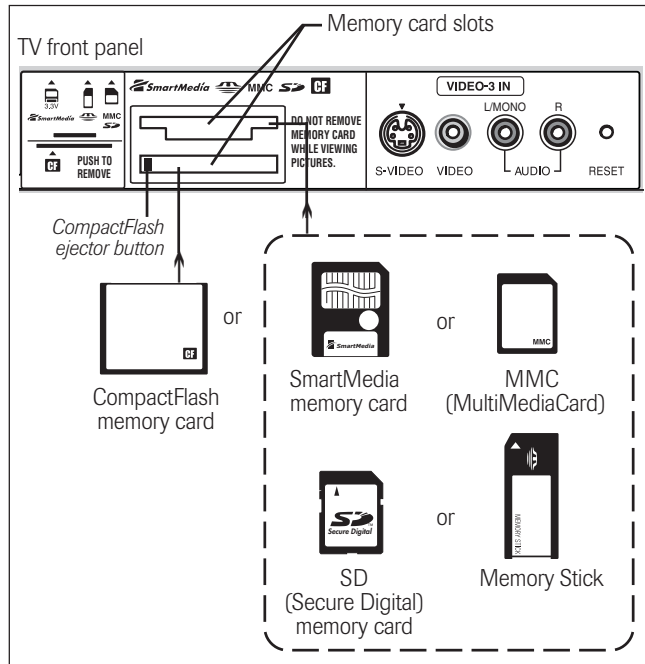

2. In a few seconds, the images automatically display on-screen, with one as a large picture and five in thumbnail format.



3. Press ◀ to rotate the large picture 90° counterclockwise.

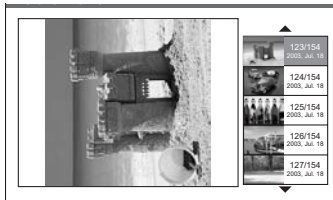

4. Press ▶ to rotate the large picture 90° clockwise.



5. Press ▲ or ▼ to select another picture as the large picture.

6. Press ENTER to view your pictures in a slide show.



#### During the slide show:

- To rotate the picture, press ▶ or ◀, and then press ENTER.
- To select another image, press ▲ or ▼, and then press ENTER.
- To stop the slide show and return to the picture viewer, press CH RTN.
- To stop the slide show and return to the regular TV screen, press EXIT.

#### To set the slide show interval:

**Note:** The picture viewer must be closed before you can set the slide show interval.

1. Press MENU and open the SETUP menu.
2. Highlight SLIDE SHOW INTERVAL and press ENTER. Select the interval from the menu sidebar (2, 5, 10, 15, or 20 seconds).

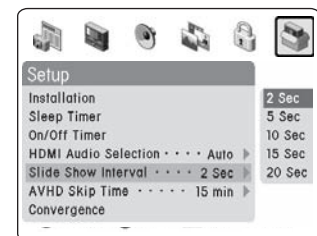

#### To close the picture viewer:

Press EXIT to close the picture viewer and return to the regular TV screen.

#### NOTICE OF POSSIBLE ADVERSE EFFECTS ON TV PICTURE TUBE

Avoid displaying stationary images on your TV screen for extended periods of time. Fixed (non-moving) images can become permanently engrained in the picture tube. **This type of damage is NOT COVERED BY YOUR WARRANTY.** See item 33 on page 4.



## Using the memory card picture viewer (continued)

To restart the picture viewer while the memory card is still inserted:

1. Press MENU and open the APPLICATIONS menu.
2. Highlight PICTURE VIEWER and press ENTER.

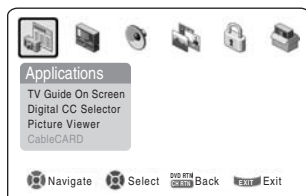

3. Follow the steps under "Viewing digital photos on your TV" on the previous page.

To close the picture viewer and remove the memory card:

1. Press EXIT to close the picture viewer and return to the regular TV screen.

**NOTE: ALWAYS CLOSE THE PICTURE VIEWER BEFORE REMOVING THE MEMORY CARD.**

*If you remove the memory card while viewing pictures, the card and/or saved data may be damaged. THIS TYPE OF DAMAGE IS NOT COVERED UNDER YOUR TOSHIBA WARRANTY.*

2. For a CompactFlash memory card, press the ejector button and then pull the card straight out from the TV.  
For all other memory cards, pull the card straight out from the TV.

## Memory card care and handling

- Use index labels made exclusively for your specific brand of memory card. Do not use commercially sold labels, which can cause a malfunction when the card is inserted or ejected.
- If the image does not appear correctly, clean the metallic area of the memory card using a soft, dry, lint-free, anti-static cloth, and then reinsert the card.
- Prevent contact of the metallic area on the memory card with dust, dirt, or other foreign particles. Do not touch the metallic area of the memory card with your hands or otherwise handle it with anything other than a soft, dry, lint-free, anti-static cloth.

**NOTE:** Toshiba is not liable for any damage caused by the use of any memory card with this TV. Toshiba will not compensate for any lost data or recordings caused by the use of such cards.

## Setting the ON/OFF timer

You can use the ON/OFF timer to turn the TV on and off at a preset time on a recurring basis.

**Note:** You must first set the time (see page 51).

To set the ON/OFF timer:

1. Press MENU and open the SETUP menu.
2. Highlight ON/OFF TIMER and press ENTER.

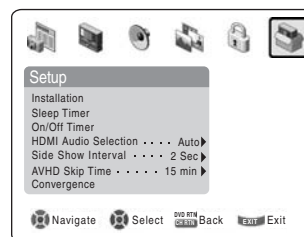

3. Press ▼ to highlight the DAY field, and then press ► to select the recurrence (weekends, weekdays, every day, etc).

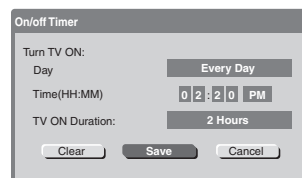

4. Press ▼ to highlight the TIME field, and then use the Number buttons to enter the time you want the TV to turn on.
5. When the AM/PM field is highlighted, press ► to select AM or PM.
6. Press ▼ to highlight the TV ON DURATION field, and then press ► to select the length of time until the TV turns off.
7. Highlight SAVE and press ENTER.
8. Turn off the TV. The TV will turn on automatically on the day(s) and at the time you set. The TV will then turn off automatically after the length of time you set in the TV ON DURATION field.

**Note:**

- When a power failure occurs, the ON/OFF timer settings may be cleared.
- To display the on time setting, press RECALL.

To turn off the ON/OFF timer:

Select NOT SET in step 3 above.





## Setting the sleep timer

You can set the sleep timer to turn off the TV after a set length of time (maximum of 3 hours).

The sleep timer turns off the TV one time only, as opposed to the ON/OFF timer, which turns off the TV on a recurring basis.

### To set the sleep timer:

Press SLEEP on the remote control to set the length of time until the TV turns off. Each time you press SLEEP, the time will increase in 10-minute increments, to a maximum of 180 minutes.

### To cancel the sleep timer:

Press SLEEP until it is set to 0.



### To set the sleep timer using the on-screen menus:

1. Press MENU and open the SETUP menu.
2. Press ▼ to highlight SLEEP TIMER and press ENTER.

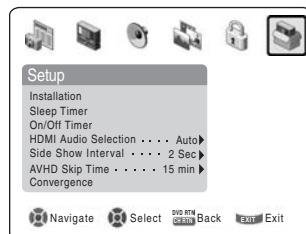

3. Press the Number buttons to enter the length of time until the TV turns off automatically.

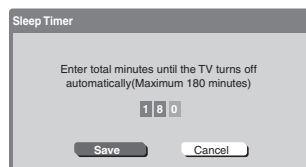

4. Highlight SAVE and press ENTER.

#### Note:

- When a power failure occurs, the sleep timer setting may be cleared.
- To display the amount of time left on the sleep timer, press RECALL.

## Displaying TV setting information on-screen

Press RECALL to display the following information on-screen:

- Current input (ANT 1, ANT 2, VIDEO 1, etc.)
- If ANT 1 or ANT 2 is the current input, whether it is Cable TV ("CABLE") or off-air ("TV")
- Channel number (if in ANT 1 or ANT 2 mode)
- Time (if set)
- Timer settings (if set)
- Remaining time on sleep timer (if set)
- Remaining time on game timer (if set)
- Stereo or SAP audio status
- V-Chip rating status
- Picture size

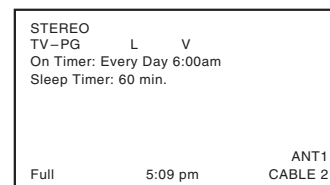

Sample RECALL screen

## Understanding the auto power off feature

The TV will automatically turn itself off after approximately 15 minutes if it is tuned to a vacant channel or a station that completes its broadcast for the day. This feature functions in ANT 1 and ANT 2 modes only.

## Understanding the last mode memory feature

If the power is cut off while you are viewing the TV, the Last Mode Memory feature automatically turns on the TV when the power is resupplied.

**NOTE:** Because the Last Mode Memory feature will cause the TV to turn on after a power failure (if it was on when the power failed), if you are viewing fixed images or special formats when the power fails, such images or formats could be displayed when the power returns. To prevent possible damage to the TV's picture tube, you should unplug the TV's power cord if it is possible that you will be away from the TV for an extended period of time after the power is restored. If you are away, the TV could turn on automatically, displaying fixed images or special formats that can become permanently engrained in the picture tube. **THIS TYPE OF DAMAGE IS NOT COVERED BY YOUR WARRANTY.** See item 33 on page 4.

## 9 Using the Locks menu

The LOCKS menu includes the RATING BLOCKING, CHANNELS BLOCK, INPUT LOCK, FRONT PANEL LOCK, GAME TIMER, and NEW PIN CODE features. You can use these features after entering the correct PIN code.

### Entering the PIN code

1. Press MENU and highlight the LOCKS menu icon.

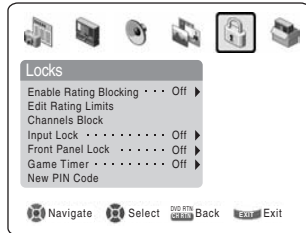

2. Press ▼, which displays the PIN code entry screen.
  - The LOCK SYSTEM screen (below) appears if a PIN code has not been stored. Press the Channel Number buttons to enter a new four-digit code, enter the code a second time to confirm, and press ENTER.



- The LOCKS ACTIVE screen (below) appears if the PIN code is already stored. Press the Channel Number buttons to enter your four-digit code and press ENTER.



If the wrong PIN code is entered, the message “Incorrect PIN code” appears. Highlight RE TRY and press ENTER. Enter the code again and press ENTER.

When the correct PIN code is entered, the LOCKS menu opens.

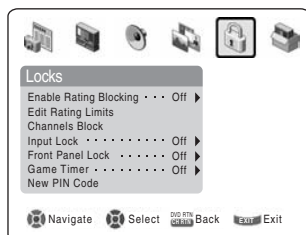

### If you cannot remember your PIN code

While the PIN code entering screen is displayed, press RECALL four times within five seconds. The PIN code will be reset and you can enter a new PIN code.

### Changing your PIN code

1. Press MENU and highlight the LOCKS menu icon.
2. Press ▼ to display the PIN code entering screen.
3. Enter your four-digit PIN code and press ENTER.
4. Press ▼ to highlight NEW PIN CODE and press ENTER.
5. Press the Number buttons to enter a new four-digit code. Retype the numbers to confirm the PIN code you entered.
6. Press ENTER. The new PIN code is now active.

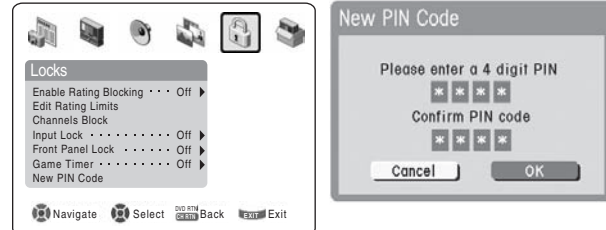

## Blocking TV programs and movies by rating (V-Chip)

Some TV programs and movies include signals that classify the content of the program (violence, sex, dialog, language). The V-Chip feature in this TV detects the signals and blocks the programs according to the ratings you select. (See the tables at right for rating descriptions.)

**Note:** Rating blocking is a function of the V-Chip feature in this TV, which supports the U.S. V-Chip system only.

### To block and unblock TV programs and movies:

1. Press MENU and highlight the LOCKS menu icon.
2. Press ▼, which displays the PIN code entering screen.
3. Enter your four-digit PIN code and press ENTER.
4. Press ▼ to highlight ENABLE RATING BLOCKING.
5. Press ► and then ▼ to select ON, and then press ENTER.

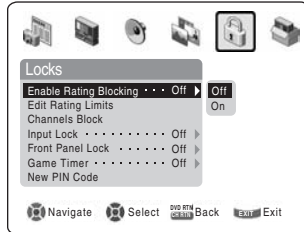

6. Press ▼ to highlight EDIT RATING LIMITS and press ENTER.

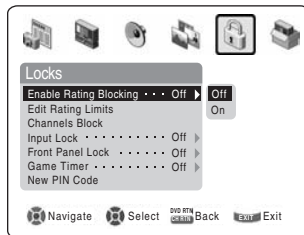

The EDIT RATING LIMITS screen (below) appears.

7. Press ▲▼◀▶ and then press ENTER to select the level of blocking you prefer. A box with an "X" is a rating that will be blocked. As you highlight a rating, a definition for the rating appears at the bottom of the screen. See notes at right.

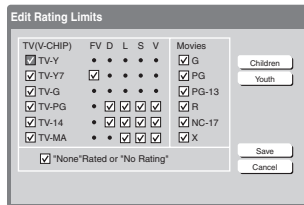

8. When done selecting the ratings you want to block, highlight SAVE and press ENTER.

Independent rating system for broadcasters	
Ratings	Description and Content themes
<b>TV-MA</b>	Mature Audience Only (This program is specifically designed to be viewed by adults and therefore may be unsuitable for children under 17.) <b>LJ</b> Crude or indecent language <b>SJ</b> Explicit sexual activity <b>VJ</b> Graphic violence
<b>TV-14</b>	Parents Strongly Cautioned (This program contains some material that many parents would find unsuitable for children under 14 years of age.) <b>DJ</b> Intensely suggestive dialog <b>LJ</b> Strong, coarse language <b>SJ</b> Intense sexual situations <b>VJ</b> Intense violence
<b>TV-PG</b>	Parental Guidance Suggested (This program contains material parents may find unsuitable for younger children.) <b>DJ</b> Some suggestive dialog <b>LJ</b> Infrequent coarse language <b>SJ</b> Some sexual situations <b>VJ</b> Moderate violence
<b>TV-G</b>	General Audience (Most parents would find this program suitable for all ages.)
<b>TV-Y7, TV-Y7FV</b>	Directed to Older Children (This program is designed for children age 7 and above. Note: Programs in which fantasy violence may be more intense or more combative than other programs in this category are designated Y7FV.)
<b>TV-Y</b>	All Children (This program is designed to be appropriate for all children.)

Independent rating system for movies	
Rating	Description and content themes
<b>X</b>	X-rated (For adults only)
<b>NC-17</b>	Not intended for anyone 17 and under
<b>R</b>	Restricted (Under 17 requires accompanying parent or adult)
<b>PG-13</b>	Parents Strongly Cautioned (Some material may be inappropriate for children under 13)
<b>PG</b>	Parental Guidance Suggested (Some material may not be suitable for children)
<b>G</b>	General Audience (Appropriate for all ages)

### Note:

- If you place an X in the box next to "None Rated or No Rating," programs rated "None" or "No Rating" will be blocked. However, if the program has no rating information provided, nothing will be displayed in the banner and ratings blocking will not be in effect.
- To display the rating of the program you are watching, press RECALL on the remote control. If it is not rated, the word "NONE" appears.

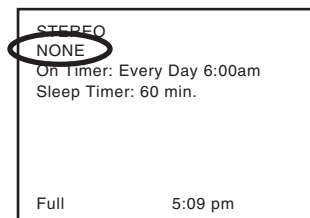
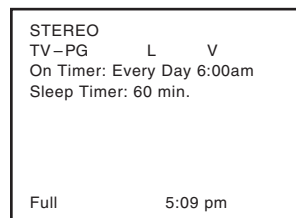

## Blocking channels

With the CHANNELS BLOCK feature, you can block specific channels. You will not be able to tune locked channels unless you clear the setting first.

### To block channels:

1. Press MENU and highlight the LOCKS menu icon.
2. Press ▼, which displays the PIN code entering screen.
3. Enter your four-digit PIN code (see page 88 for details).
4. Press ▼ to highlight CHANNELS BLOCK and then press ENTER.

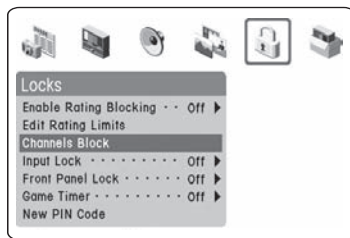

5. Press ▲▼◀▶ to highlight the channel you want to block, then press ENTER, which puts an X in the box next to that channel.

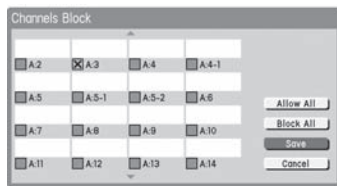

6. Repeat step 5 for other channels you want to block.
7. Highlight SAVE and press ENTER.

### To unlock individual channels:

In step 5 above, press ▲▼◀▶ to highlight the channel you want to unblock, and then press ENTER to remove the X from the box.

### To block all channels at once:

Highlight BLOCK ALL in step 5 above.

### To unlock all locked channels at once:

Highlight ALLOW ALL in step 5 above.

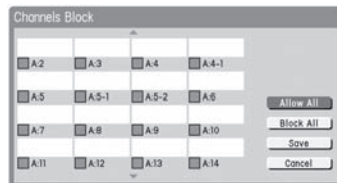

## Unlocking programs temporarily

If you try to watch a TV program that exceeds the rating limits you set, the TV enters program lock mode.

You can either unlock the program temporarily or select a non-locked program to watch.

This program exceeds the rating limit you set.  
Push 'mute' to enter PIN.

### To temporarily unlock the program:

1. Press MUTE.
2. Enter your four-digit PIN code and press ENTER.

If the correct code is entered, the program lock mode is released and the normal picture appears. All locking is disabled until the TV is turned off, and will be enabled when the TV is turned on again.



## Locking video inputs

You can use the INPUT LOCK feature to lock the video input sources (VIDEO 1, VIDEO 2, VIDEO 3, ColorStream HD-1, ColorStream HD-2, DVI/HDCP) and channels 3 and 4.

You will not be able to view the input sources or channels until you turn off the input lock.

### To lock the video inputs:

1. Press MENU and highlight the LOCKS menu icon.
2. Press ▼ to display the PIN code entering screen.
3. Enter your four-digit PIN code and press ENTER.
4. Press ▼ to highlight INPUT LOCK and press ENTER.
5. Press ▼ to select the level of video input locking you prefer, as described below:

**VIDEO:** Locks VIDEO 1, VIDEO 2, VIDEO 3, ColorStream HD1/HD2, and HDMI 1 and HDMI 2.

**VIDEO+:** Locks VIDEO 1, VIDEO 2, VIDEO 3, ColorStream HD1/HD2, HDMI 1 and HDMI 2, and channels 3 and 4. Select VIDEO+ if you use the antenna terminal to play a video tape.

**Note:** Make sure the POP is not on channel 3 or 4.

**OFF:** Unlocks all video input sources.

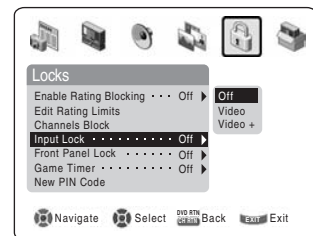

## Using the GameTimer™

You can use the GameTimer to set a time limit for playing a video game (30–120 minutes). When the GameTimer is activated, the TV enters VIDEO LOCK mode and locks out the input source for the video game device.

### To set the GameTimer™:

1. Press MENU and highlight the LOCKS menu icon.
2. Press ▼ to display the PIN code entering screen.
3. Enter your four-digit PIN code and press ENTER.
4. Press ▼ to highlight GAME TIMER and press ENTER.
5. Press ▼ to select the length of time until the VIDEO LOCK is activated (30, 60, 90 or 120 minutes) and press ENTER.

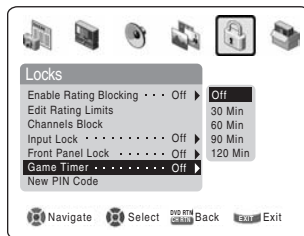

### To cancel the GameTimer™:

Select OFF in step 2 above.

### To deactivate the video lock once the GameTimer has activated it:

Set the VIDEO LOCK to OFF (see “Locking video inputs” on page 90).

#### Note:

- A message will appear on-screen when 10 minutes, 3 minutes, and 1 minute remain on the GameTimer.
- If the TV loses power with time remaining on the GameTimer, when power is restored the TV will enter VIDEO LOCK mode, as if the GameTimer has expired, and you will have to deactivate the video lock (as described above).

### NOTICE OF POSSIBLE ADVERSE EFFECTS ON TV PICTURE TUBE

Avoid displaying stationary images on your TV screen for extended periods of time. Fixed (non-moving) images (such as still PIP/POP windows, black/gray bars in wide-screen picture or PIP/POP formats, or some video games) can become permanently engrained in the picture tube. **This type of damage is NOT COVERED BY YOUR WARRANTY.** See item 33 on page 4.

## Using the front panel lock feature

You can lock the front panel buttons to prevent your settings from being changed accidentally (by children, for example). When the front panel lock is ON, no control buttons on the TV front panel will operate except POWER.

### To lock the front panel:

1. Press MENU and highlight the LOCKS menu icon.
2. Press ▼ to display the PIN code entering screen.
3. Enter your four-digit PIN code and press ENTER.
4. Press ▼ to highlight FRONT PANEL LOCK.
5. Press ▼ to highlight ON and press ENTER.

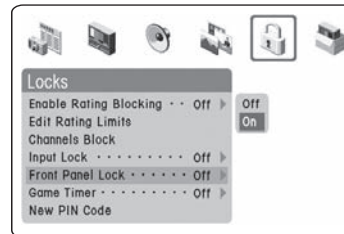

When the front panel is locked and a button on the front panel is pressed, the message “Not Available” appears.

### To unlock the front panel:

Highlight OFF in step 2 above, or press and hold the VOLUME ◀ button on the TV front panel for about 10 seconds until the volume icon appears on-screen.

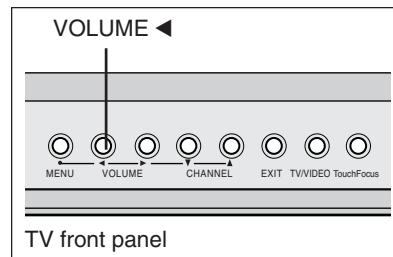



# 10 Troubleshooting

Before calling a service technician, please check the following table for a possible cause of the problem and some solutions.

<b>Problem</b>	<b>Solution</b>
TV will not turn on	<ul style="list-style-type: none"> <li>• Make sure the power cord is plugged in, and then press POWER.</li> <li>• The remote control batteries may be dead. Replace the batteries or try the front panel buttons.</li> <li>• Press the RESET button on the TV front panel (page 9).</li> </ul>
Picture problems	<ul style="list-style-type: none"> <li>• Check the antenna/cable connections (Chapter 2).</li> <li>• Press INPUT on the remote control or TV/VIDEO on the TV front panel and select a valid video input source (page 67). If no device is connected to any of the inputs on the TV, no picture will display when you select that particular input source. For device connection details, see Chapter 2.</li> <li>• Antenna reception may be poor. Use a highly directional outdoor antenna (if applicable).</li> <li>• The station may have broadcast difficulties. Try another channel.</li> <li>• Adjust the picture qualities (page 77).</li> <li>• If you are using a VCR, make sure the TV/VCR button on the remote control is set correctly (page 26).</li> <li>• If you have two VCRs connected to your TV, do not connect the same VCR to the TV's output and input connections at the same time (page 18).</li> <li>• Do not connect a standard video cable and an S-video cable to VIDEO-1 or VIDEO-2 on the TV back (or VIDEO-3 on the TV front) at the same time (Chapter 2).</li> </ul>
<i>Noisy picture</i>	<ul style="list-style-type: none"> <li>• If you are watching a tuned analog channel (off-air broadcast or Cable TV), set the CableClear DNR feature to AUTO to reduce visible interference in the TV picture (page 78).</li> </ul>
<i>Video Input Selection problems</i>	<ul style="list-style-type: none"> <li>• If the Input Selection window does not appear when you press INPUT on the remote control or TV/VIDEO on the TV front panel, press INPUT or TV/VIDEO a second time, which will change to the next video input source and display the Input Selection window.</li> </ul>
<i>Cannot view external signals or channel 3 or 4</i>	<ul style="list-style-type: none"> <li>• If you cannot view signals from external devices connected to VIDEO 1, VIDEO 2, VIDEO 3, or ColorStream,<sup>®</sup> or from channels 3 or 4, make sure the INPUT LOCK is set to OFF (page 90).</li> </ul>
<i>Black box on screen</i>	<ul style="list-style-type: none"> <li>• Set the CLOSED CAPTION feature to OFF (page 80).</li> </ul>
<i>Poor color or no color</i>	<ul style="list-style-type: none"> <li>• The station may have broadcast difficulties. Try another channel.</li> <li>• Adjust the TINT and/or COLOR (page 77).</li> <li>• If the red, green, and blue color guns become misaligned, the picture may appear out of focus. Press the TouchFocus button on the TV front panel to automatically adjust the color convergence, or manually adjust the color convergence (page 49).</li> <li>• When the ColorStream signal source is active, the VIDEO OUT terminal outputs blank video. To receive video from the VIDEO OUT signal, a standard video or S-video IN jack must be used instead of the ColorStream connections.</li> </ul>
<i>POP problems</i>	<ul style="list-style-type: none"> <li>• The VIDEO OUT jack will not output the POP picture (pages 18 and 74).</li> </ul>
Memory card/picture viewer problems	<ul style="list-style-type: none"> <li>• Make sure you are using a supported or valid memory card format (page 84).</li> <li>• Make sure you have saved the picture files in the correct file format (page 84).</li> <li>• The card may be inserted improperly. Remove the card and reinsert it (page 84).</li> <li>• The memory card may be empty.</li> <li>• The memory card may be damaged.</li> </ul>
HDMI/DVI problems	<ul style="list-style-type: none"> <li>• If your HDMI/DVI device is not working, make sure the device is plugged in to the corresponding HDMI IN port you are selecting. (page 19 and 50)</li> </ul>

## Chapter 10: Troubleshooting

Problem	Solution
Sound problems	<ul style="list-style-type: none"><li>• Check the antenna/cable connections (see Chapter 2).</li><li>• The station may have broadcast difficulties. Try another channel.</li><li>• The sound may be muted. Press VOLUME.</li><li>• If you hear no sound, try setting the MTS feature to STEREO mode (page 81).</li><li>• Make sure the SPEAKERS function in the AUDIO SETUP menu is set correctly (page 83).</li><li>• If you are not receiving a second audio program from a known SAP source, make sure the MTS feature is set to SAP mode (page 81).</li><li>• If you hear audio that seems “incorrect” for the program you are watching (such as music or a foreign language), the SAP mode may be on. Set the MTS feature to STEREO mode (page 81).</li><li>• When using an external audio amplifier, if you connect the amplifier to the VAR. AUDIO OUT jacks, the volume of the TV and amplifier must be set above 0 or you will not hear any sound (page 20).</li></ul>
Remote control problems	<ul style="list-style-type: none"><li>• Make sure the remote control is set to the correct device mode (page 27).</li><li>• Remove all obstructions between the remote control and the TV.</li><li>• The remote control batteries may be dead. Replace the batteries (page 27).</li><li>• Your TV remote control may not operate certain features on your external device. Refer to the owner’s manual for your other device to determine its available features. If your TV remote control does not operate a specific feature on another device, use the remote control that came with the device (page 27).</li><li>• If the TV stops responding to the controls on the remote control or TV front panel and you cannot turn off the TV, press the RESET button on the front panel (see page 9 for details). If the TV still does not act as expected, use the Restore Factory Defaults procedure as described on page 52.</li></ul>
Channel tuning problems	<ul style="list-style-type: none"><li>• Make sure the remote control is set to the correct device mode (page 27).</li><li>• The channel may have been erased from the channel memory by the CHANNEL ADD/DELETE feature. Add the channel to the channel memory (page 42).</li><li>• The channel may be blocked by the CHANNELS BLOCK feature. Unblock the channel (page 90).</li><li>• If you are unable to tune digital channels, check the antenna configuration (page 41). If you are still unable to tune digital channels, clear all channels from the channel list (page 42) and reprogram channels into the channel memory (page 41). If you are still unable to tune digital channels, use the Restore Factory Defaults procedure as described on page 52.</li></ul>
Closed caption problems	<ul style="list-style-type: none"><li>• If the program or video you selected is not closed-captioned, no captions will display on-screen (page 80).</li><li>• If text is not available, a black rectangle may appear on-screen. If this happens, turn off the closed caption feature (page 80).</li><li>• A closed caption signal may not display correctly in the following situations: a) when a videotape has been dubbed; b) when the signal reception is weak; or c) when the signal reception is nonstandard (page 80).</li></ul>
Rating Blocking (V-Chip) problems	<ul style="list-style-type: none"><li>• If you forget your PIN code: While the PIN code entering screen is displayed, press RECALL four times within 5 seconds. The PIN code you stored will be reset (page 88).</li><li>• The V-Chip feature is available for the U.S. V-Chip system only (page 89).</li></ul>
Recording problems	<ul style="list-style-type: none"><li>• If you use the TV’s remote control to start recording, you will not be able to change inputs (page 67), change channels (page 69), open the POP window (page 74), or open the FAV SCAN multi-window (page 76). If you attempt to do so, the message “Not Available While Recording” will appear on-screen.</li><li>• It is recommended that you use the TV’s remote control to start recording. If you use a device other than the TV’s remote control to start recording and then attempt to access a feature that is normally denied during recording (POP mode, FAV SCAN mode, changing inputs, changing channels), the recorded audio and/or video may not be what you intended to record. See pages 67, 69, 74, and 76.</li></ul>
Other problems	<ul style="list-style-type: none"><li>• If your TV’s problem has not been addressed in this Troubleshooting section or the recommended solution has not worked, use the Restore Factory Defaults procedure as described on page 52.</li></ul>

## LED indications

The green and red LED lights are on the TV front panel, to the right of the POWER button.

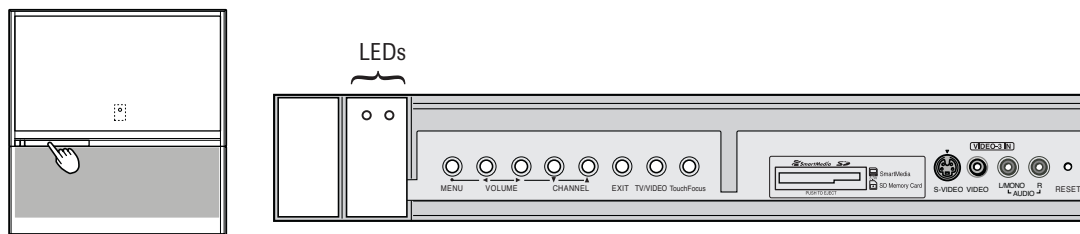

LED Indication	Description
Green blinks 3 times (after the power cord is plugged in).	Wait about 30 seconds until the Green LED lights continuously, and then press POWER to turn ON the TV.
Green lights solid.	Indicates that the TV power cord is plugged in and the power is OFF. This is called "standby mode."
Red lights solid.	Indicates that the TV power cord is plugged in and the power is ON.
Red blinks.	Press POWER to turn OFF the TV, and unplug the power cord. Plug in the power cord again and press POWER to turn ON the TV. If the problem persists, turn OFF the TV, unplug it, and contact a Toshiba Authorized Service Center.
Green blinks at 3-second intervals.	The fan for cooling the CableCARD has stopped. Press POWER to turn OFF the TV, unplug the power cord, and contact a Toshiba Authorized Service Center.

## TV Guide On Screen® FAQs

The following are frequently asked questions about the TV Guide On Screen system. The answers represent the most likely solutions to the problem.

### SETUP

1. **Q: What if I move and my ZIP code or postal code changes?**

A: Highlight SETUP in the Service Bar. Press ▼ to highlight CHANGE SYSTEM SETTINGS (page 65), and then press ENTER. Follow the on-screen prompts to enter new information (see Chapter 3 for details). It can take up to 24 hours to receive new data.

2. **Q: What if I change my cable hook-up to antenna or vice versa?**

A: Highlight SETUP in the Service Bar. Press ▼ to highlight CHANGE SYSTEM SETTINGS (page 65), and then press ENTER. Follow the on-screen prompts to enter new input information and rescan channels for the new input (see Chapter 3 for details).

3. **Q: What if I change cable boxes?**

A: Highlight SETUP in the Service Bar. Press ▼ to highlight CHANGE SYSTEM SETTINGS (page 65), and then press ENTER. Follow the on-screen prompts to enter new input information and rescan channels for the new input (see Chapter 3 for details).

4. **Q: I used to have a cable box, but now I get direct cable. What do I do?**

A: Highlight SETUP in the Service Bar. Press ▼ to highlight CHANGE SYSTEM SETTINGS (page 65), and then press ENTER. Follow the on-screen prompts to enter new input information and rescan channels for the new input (see Chapter 3 for details).

5. **Q: If I add a recorder or change my cable service, how do I change my Setup information?**

A: Highlight SETUP in the Service Bar. Press ▼ to highlight CHANGE SYSTEM SETTINGS (page 65), and then press ENTER. Follow the on-screen prompts to enter new information (see Chapter 3 for details). It can take up to 24 hours to receive new data.

6. **Q: Why does it take up to 24 hours for the TV Guide On Screen system to be ready for use?**

A: The initial setup process consists of finding the stations in your area that carry the TV Guide On Screen system data and tuning to those stations to receive the setup and listings data.

## TV Guide On Screen FAQs (continued)

## SETUP (continued)

7. Q: **I had a power outage. Do I need to go through initial setup of the TV Guide On Screen system again?**  
 A: No. The information you entered is stored in the TV Guide On Screen system memory.  
*Note:* For Cable box users, the TV must be OFF and the Cable box must be left ON for the TV Guide On Screen system to receive channel line-up information.
8. Q: **How do I connect the G-LINK (IR blaster) cable to the G-LINK™ input on the TV?**  
 A: See Chapter 2: Connecting your TV in this manual. You also can refer to the TV Guide On Screen prompts during VCR or Cable box setup.
9. Q: **When will I be able to view my TV program listings and use other TV Guide On Screen system features?**  
 A: The TV Guide On Screen system will be ready for use within 24 hours of initial setup.
10. Q: **What should I do if I cannot complete initial setup?**  
 A: If you are unable to complete initial setup using the owner's manual and the on-screen prompts, please call Toshiba's National Service Division at 1-800-631-3811.
11. Q: **If I make a mistake during setup, how do I go back to the previous step?**  
 A: Complete the remaining setup steps. When "Confirming Your Settings" appears, select "No, repeat setup process." Follow the on-screen prompts and input the correct information.
12. Q: **What if the channel number is not visible on my cable box?**  
 A: Your cable box may be defaulting to a clock or time display once the channel changes. Watch the box carefully when testing the cable box brand code to see if the channel changes to 09.
13. Q: **Why won't my VCR turn on?**  
 A: There are several possibilities:
- An incorrect or "no VCR" code was entered during the TV Guide On Screen initial setup. Press the GUIDE button on the remote control, and then press ► to highlight SETUP. Press ▼ to highlight "Change system settings," and then press ENTER. Follow the on-screen prompts to select the correct VCR information.
  - Make sure the G-LINK (IR blaster) cable is connected correctly (see page 25).
  - The VCR record timer is on. Turn off the timer.
  - The wired remote VCR is incompatible.

## CHANNEL LINE-UPS &amp; LISTINGS

14. Q: **Why aren't all my channels initially displayed?**  
 A: After initial setup, approximately 120 channels are automatically displayed. The user may use the "Change channel display" feature to turn ON or OFF additional channels.  
*Note:* Even though you have the option of enabling many more channels, the system may not have the memory capacity to hold detailed program descriptions for all of them.
15. Q: **When I opened the TV Guide On Screen system, I was asked to choose from more than one channel lineup. What should I do?**  
 A: Select the lineup that most closely matches the one for your area. If after you choose the lineup, you want to make changes to it, highlight SETUP in the Service Bar. Press ▼ to select CHANGE CHANNEL DISPLAY. Follow the on-screen instructions.
16. Q: **Why do all my channels display "No Listing?"**  
 A: The TV Guide On Screen system has not yet received its data download. The phrase "No Listings" will be replaced with program information during the next download cycle, which will occur within the next 24-hour period.
17. Q: **Why do some of my channels display "No Listing?"**  
 A: There are several possibilities:
- The channels in question were recently turned ON (in Change channel display) and TV Guide On Screen has yet to receive its next data download.
  - After completing the initial setup, the first data download of the day was interrupted by a VCR recording.
  - The TV power cord was left unplugged for an extended period of time and the TV Guide On Screen system was unable to receive program listings during the scheduled download cycle.
  - Poor reception caused some of the data to be missed.
  - The cable box was turned OFF. The TV power cord must be plugged in and the cable box must be ON.
  - A/V Cable: The VCR was turned OFF. If the connection includes stereo cables with cable box to VCR and stereo connection from VCR to television, the VCR must be ON.
18. Q: **A show entry in the TV Guide On Screen system reads "No Listing." What does that mean?**  
 A: Show information for that entry was not available during the last TV Guide On Screen system information update (download). Show information is updated on a daily basis.

## TV Guide On Screen FAQs (continued)

19. Q: **I have seen the word “download” in reference to the TV Guide On Screen system. What does that mean?**

A: “Download” refers to the times throughout the day when the TV Guide On Screen system is *receiving* channel and listings information from your Cable or over-the-air antenna transmission.

20. Q: **After some show titles, I have noticed from 1 to 4 stars (\*\*\*\*). What does that mean?**

A: These stars are a broadcast-industry ratings system used to inform you of a show’s quality. The more stars, the better the rating.

21. Q: **What do the colors for shows in the Listings and Search screens indicate?**

A: Green = Sports; Dark Blue = Children’s; Purple = Movies; Teal = Other Show.

22. Q: **How do I add, delete, or change the assigned number of channels on the TV Guide On Screen system?**

A: See the “Change channel display” section in the TV Guide On Screen owner’s manual.

23. Q: **Why are some of my channels listed on the wrong number?**

A: There are several possibilities:

- Incorrect channel lineup was selected. Access “Change system settings” and choose “Yes, but my channel lineup is incorrect,” and then reselect the correct lineup.
- Channel line-up changes have not yet been processed. Use the “Change channel display” feature to make adjustments.
- Initial setup was done incorrectly (that is, the wrong ZIP/postal code was entered.) Redo the initial setup.

24. Q: **Why doesn’t the program highlighted match up with the video window on my TV screen?**

A: There are several possibilities:

- The station in question made a late change to its scheduled program listing and the TV Guide On Screen system has not yet been updated.
- The TV is receiving broadcasts through a modified or boosted antenna system or a satellite dish (not supported by the TV Guide On Screen system).
- Initial setup was done incorrectly. (i.e., the wrong ZIP/postal code was entered.) Redo the initial setup.
- Incorrect channel lineup was selected. Access “Change system settings” and choose “Yes, but my channel lineup is incorrect,” and then reselect the correct lineup.
- The video window may be locked. Press SPLIT to unlock.

25. Q: **Can I move my favorite stations to the top of the TV Guide On Screen display screen?**

A: Yes. Use the “Change channel display” feature to make adjustments. Highlight the station call letters to be moved, then use the BLUE, GREEN, and/or Number buttons to reassign the position of the station.

## OPERATIONS

26. Q: **How can I look for a specific show in the TV Guide On Screen system?**

A: SEARCH lets you find shows by category (Alphabetical, HDTV, Movies, Sports, Children, Educational, News, Variety, Series) or by Keyword.

27. Q: **My cable box will not change channels with the TV Guide On Screen system. What’s wrong?**

A: There are several possibilities:

- The incorrect cable box code was entered during TV Guide On Screen initial setup. Redo initial setup.
- The G-LINK (IR blaster) cable may not be connected properly (see page 25).
- The cable box has no remote capability and is incompatible.

28. Q: **How do I resize or close the Info window?**

A: Press the INFO button on the remote control to resize the Info window. Press the INFO button again to close the Info window.

29. Q: **Is there a way to go directly to the next day’s listings without scrolling through each time slot?**

A: Yes. Highlight the station you want to look ahead, use the Channel Number buttons on the remote control to enter “24,” and then press MENU. In the resulting menu, press ▼ two times to scroll down to select the HOURS AHEAD option, and then press ENTER.

30. Q: **Why can’t I record a show? All I get is snow or a blue screen.**

A: There are several possibilities (without a cable box):

- The recording unit was not connected or set up correctly.
- The incorrect channel lineup was selected. Press GUIDE and then ► to highlight SETUP. Press ▼ to highlight “Change system settings,” and then press ENTER. Follow the on-screen prompts to select the correct channel lineup.



## TV Guide On Screen FAQs (continued)

### OPERATIONS (continued)

31. Q: **Why won't my VCR change channels and why does it change to the wrong channel?**  
 A: There are two possibilities (with a cable box):
- The VCR is not set on the correct output channel. Set the VCR to 03, 04, or whichever output channel is set by your cable system.
  - The VCR and/or cable box are hooked up incorrectly. Refer to your VCR owner's manual or contact your Cable TV company for proper wiring procedures.
32. Q: **Is Help available in the TV Guide On Screen system? If so, how do I find it?**  
 A: Yes. Highlight any of the five main Services (Listings, Schedule, Recordings, Setup, Search) and press the INFO key on the remote control. An expanded Info Box displays additional help information. Press INFO again to close the box.  
 Help is also available in a panel menu. Press INFO to display an expanded Info Box. Press INFO again to close the box.

### RECORD/REMIND

33. Q: **Can I tune to a different channel while recording a program?**  
 A: No.
34. Q: **How many programs can be scheduled for RECORD in the GUIDE?**  
 A: There is no limit to the number of shows that can be programmed into the schedule memory.
35. Q: **If a program is scheduled to RECORD on a Regular basis, does it count as five?**  
 A: No, whether a program is scheduled ONCE, REGULARLY, or WEEKLY, it only counts as one show in the RECORD stack memory.
36. Q: **If I have a power failure, will I need to reset the recorded shows I have already programmed?**  
 A: The start times and channel numbers of shows that have been programmed will be retained in the memory of the TV Guide On Screen system. Titles will appear once listings are restored.
37. Q: **Can I set a Record or Remind event without highlighting a show title in the TV Guide On Screen system?**  
 A: Yes. TV Guide On Screen has a Manual Record and Remind feature. Highlight SCHEDULE in the Service Bar, and press MENU. Choose the event type, press ENTER, and then enter the date, start and stop time, channel number, and so forth.
38. Q: **What do the frequencies for Record and Remind mean?**  
 A: Once—records/reminds the show one time.  
 Daily (manual only)—records the time, channel, input, recorder combination Monday through Friday.  
 Regularly— records/reminds the show every time the show airs on the same channel and starts at the same time.  
 Weekly— records/reminds the show each time the show airs on the same day of the week, on the same channel and starts at the same time.  
 Off (not cancel)—keeps the show in the list but will not record/remind the show until the frequency is changed.

# 11 Appendix

## Specifications

### NOTE:

- **This model complies with the specifications listed below.**
- **Designs and specifications are subject to change without notice.**
- **This model may not be compatible with features and/or specifications that may be added in the future.**

### Television System

NTSC standard  
ATSC standard (8VSB)  
Digital Cable (64 QAM, 256 QAM; in-the-clear, unencrypted\*)

*\*Encrypted channels can be viewed on this TV using a CableCARD. See page 12 for details.*

### Channel Coverage

VHF: 2 through 13  
UHF: 14 through 69  
Cable TV: Mid band (A-8 through A-1, A through I)  
Super band (J through W)  
Hyper band (AA through ZZ, AAA, BBB)  
Ultra band (65 through 94, 100 through 125)

### Power Source

120 V AC, 60 Hz

### Power Consumption

220 W (average)  
45 W in standby mode (power cord plugged in and power OFF)

### Audio Power

15 W + 15 W

### Speaker Type

Two 6-5/16 inches (16 cm) round

### Video/Audio Terminals

#### S-VIDEO INPUT:

Y : 1 V(p-p), 75 ohm, negative sync.  
C : 0.286 V(p-p) (burst signal), 75 ohm

#### VIDEO/AUDIO INPUT:

VIDEO: 1 V(p-p), 75 ohm, negative sync.  
AUDIO: 150 mV(rms) (30% modulation equivalent, 22 k ohm or greater)

#### ColorStream® (component video) HD INPUT:

Y : 1V(p-p), 75 ohm  
PR: 0.7 V(p-p), 75 ohm  
PB: 0.7 V(p-p), 75 ohm  
AUDIO: 150 mV(rms), 22 k ohm or greater  
Suggested resolutions: 1080i, 480p, 480i, 720p

**NOTE:** This TV does not provide ColorStream HD OUTPUT.

### Video/Audio Terminals (continued)

#### HDMI™ INPUT:

HDMI compliant (type A connector)  
HDCP compliant  
E-EDID\*\* compliant  
Suggested scan rates: 1080i, 480p, 480i, 720p  
HDMI Audio: 2-channel PCM; 32/44.1/48 kHz sampling frequency; 16/20/24 bits per sample

**NOTE:** This TV does not provide HDMI OUTPUT.

#### VIDEO/AUDIO OUTPUT (also for recording):

VIDEO: 1 V(p-p), 75 ohm, negative sync.  
AUDIO: 150 mV(rms) (30% modulation equivalent, 2.2 k ohm or less)

#### VARIABLE AUDIO OUTPUT:

0–300 mV(rms) (30% modulation equivalent, 2.2 k ohm or less)

#### G-LINK™ and IR OUTPUT:

3 V(p-p), 3.5 mm mono socket (IR blaster cables supplied)

#### IEEE-1394 INPUT/OUTPUT:

IEEE-1394 compliant

### Dimensions

51HX94: Width: 47-9/16 inches (1208 mm)  
Height: 50-1/2 inches (1283 mm)  
Depth: 22-1/2 inches (572 mm)  
57HX94: Width: 52-3/4 inches (1340 mm)  
Height: 55-3/4 inches (1416 mm)  
Depth: 23-7/8 inches (606 mm)

### Weight

51HX94: 169 lbs (76.6 kg)  
57HX94: 204 lbs (92.5 kg)

### Supplied Accessories

- Two dual-wand IR blaster cables
- Remote control with two size "AA" alkaline batteries

\*\* E-EDID = Enhanced-Extended Display Identification

## Limited United States Warranty for 27" FST PURE® and All Larger TVs and All HD-Ready and HD Integrated TVs

Toshiba America Consumer Products, L.L.C. ("TACP") makes the following limited warranties to original consumers in the United States. THESE LIMITED WARRANTIES EXTEND TO THE ORIGINAL CONSUMER PURCHASER OR ANY PERSON RECEIVING THIS TELEVISION AS A GIFT FROM THE ORIGINAL CONSUMER PURCHASER AND TO NO OTHER PURCHASER OR TRANSFEREE.

PRODUCTS PURCHASED IN THE U.S.A. AND USED IN CANADA ARE NOT COVERED BY THESE WARRANTIES.

PRODUCTS PURCHASED IN CANADA AND USED IN THE U.S.A. ARE NOT COVERED BY THESE WARRANTIES.

### Limited One (1) Year Warranty on Parts and Labor\*

TACP warrants this television and its parts against defects in materials or workmanship for a period of one (1) year after the date of original retail purchase. DURING THIS PERIOD, TACP WILL, AT TACP'S OPTION, REPAIR OR REPLACE A DEFECTIVE PART WITH A NEW OR REFURBISHED PART WITHOUT CHARGE TO YOU FOR PARTS OR LABOR. TACP Authorized Service Station personnel will come to your home when warranty service is required. Depending on the type of repair required, either the service will be performed in your home or the set will be taken to the TACP Authorized Service Station for repair and returned to your home at no cost to you.

### Limited Two (2) Year Warranty on Picture Tube\*

TACP warrants the picture tube in this television against defects in materials or workmanship for a period of two (2) years after the date of original retail purchase. DURING THIS PERIOD, TACP WILL, AT TACP'S OPTION, REPAIR OR REPLACE A DEFECTIVE PICTURE TUBE WITH A NEW OR REFURBISHED PICTURE TUBE WITHOUT CHARGE TO YOU, EXCEPT THAT, IF A DEFECTIVE PICTURE TUBE IS REPAIRED OR REPLACED AFTER ONE (1) YEAR AFTER THE DATE OF THE ORIGINAL RETAIL PURCHASE, YOU MUST PAY ALL LABOR CHARGES INVOLVED IN THE REPAIR OR REPLACEMENT OF SUCH PICTURE TUBE. TACP Authorized Service Station personnel will come to your home when warranty service is required. Depending on the type of repair required, either the service will be performed in your home or the set will be taken to the TACP Authorized Service Station for repair and returned to your home at no cost to you.

### Rental Units

The warranty for rental units begins with the date of first rental or thirty (30) days from the date of shipment to the rental firm, whichever comes first.

### \*Limited Warranty for Commercial Units

TACP warrants televisions sold and used for commercial purposes as follows: all parts are warranted against defects in materials or workmanship for a period of ninety (90) days after the date of original purchase. DURING THIS PERIOD, TACP WILL, AT TACP'S OPTION, REPAIR OR REPLACE A DEFECTIVE PART WITH A NEW OR REFURBISHED PART WITHOUT CHARGE TO YOU.

### Owner's Manual and Product Registration

Read this owner's manual thoroughly before operating this television.

Complete and mail the enclosed product registration card or register your product on-line at [www.tacp.toshiba.com/service](http://www.tacp.toshiba.com/service) as soon as possible. By registering your product you will enable TACP to bring you new products specifically designed to meet your needs and help us to contact you in the unlikely event a safety notification is required under the Consumer Product Safety Act. Failure to register your product does not diminish your warranty rights.

### Your Responsibility

THE ABOVE WARRANTIES ARE SUBJECT TO THE FOLLOWING CONDITIONS:

- (1) You must provide your bill of sale or other proof of purchase.
- (2) All warranty servicing of this television must be performed by an Authorized TACP Service Station.
- (3) These warranties are effective only if the television is purchased and operated in the U.S.A. or Puerto Rico.
- (4) Labor charges for installation, setup, adjustment of customer controls, and installation or repair of antenna systems are not covered by these warranties. Reception problems caused by inadequate antenna systems are your responsibility.
- (5) Warranties extend only to defects in materials or workmanship as limited above, and do not extend to any television or parts that have been lost or discarded by you or to damage to the television or parts caused by fires, misuse, accident, Acts of God (such as lightning or fluctuations in electric power), improper installation, improper maintenance, or use in violation of instructions furnished by TACP; use or malfunction through simultaneous use of this product and connected equipment; or to units that have been modified or had the serial number removed, altered, defaced, or rendered illegible.

### How to Obtain Warranty Services

If, after following all of the operating instructions in this manual and checking the "Troubleshooting" section, you find that service is needed:

- (1) To find the nearest TACP Authorized Service Station, visit TACP's web site at [www.tacp.toshiba.com/service](http://www.tacp.toshiba.com/service) or call toll free 1-800-631-3811.
- (2) Present your bill of sale or other proof of purchase to the Authorized Service Station.

**For additional information, visit TACP's web site:  
[www.tacp.toshiba.com](http://www.tacp.toshiba.com).**

ALL WARRANTIES IMPLIED BY THE LAW OF ANY STATE OF THE U.S.A., INCLUDING THE IMPLIED WARRANTIES OF MERCHANTABILITY AND FITNESS FOR A PARTICULAR PURPOSE, ARE EXPRESSLY LIMITED TO THE DURATION OF THE LIMITED WARRANTIES SET FORTH ABOVE. WITH THE EXCEPTION OF ANY WARRANTIES IMPLIED BY THE LAW OF ANY STATE OF THE U.S.A. AS HEREBY LIMITED, THE FOREGOING WARRANTY IS EXCLUSIVE AND IN LIEU OF ALL OTHER WARRANTIES, GUARANTEES, AGREEMENTS, AND SIMILAR OBLIGATIONS OF TACP WITH RESPECT TO THE REPAIR OR REPLACEMENT OF ANY PARTS. IN NO EVENT SHALL TACP BE LIABLE FOR CONSEQUENTIAL OR INCIDENTAL DAMAGES (INCLUDING, BUT NOT LIMITED TO, LOST PROFITS, BUSINESS INTERRUPTION, OR MODIFICATION OR ERASURE OF RECORDED DATA CAUSED BY USE, MISUSE, OR INABILITY TO USE THIS PRODUCT).

No person, agent, distributor, dealer, or company is authorized to change, modify, or extend the terms of these warranties in any manner whatsoever. The time within which action must be commenced to enforce any obligation of TACP arising under this warranty or under any law of the United States or of any state thereof is hereby limited to 90 days from the date you discover, or should have discovered, the defect. This limitation does not apply to implied warranties arising under the law of any state of the U.S.A.

THIS WARRANTY GIVES YOU SPECIFIC LEGAL RIGHTS, AND YOU MAY ALSO HAVE OTHER RIGHTS, WHICH MAY VARY FROM STATE TO STATE IN THE U.S.A. SOME STATES OF THE U.S.A. DO NOT ALLOW LIMITATIONS ON THE DURATION OF AN IMPLIED WARRANTY, LIMITATIONS ON THE TIME WITHIN WHICH AN ACTION MAY BE BROUGHT, OR THE EXCLUSION OR LIMITATION OF INCIDENTAL OR CONSEQUENTIAL DAMAGES; THEREFORE, THE ABOVE LIMITATIONS OR EXCLUSIONS MAY NOT APPLY TO YOU UNDER SUCH CIRCUMSTANCES.

FST PURE® is a registered trademark of Toshiba America Consumer Products, L.L.C.  
071304

## Limited Canada Warranty for 32" and Larger TVs

Toshiba of Canada Limited ("TCL") makes the following limited warranties to original consumers in Canada.

THESE LIMITED WARRANTIES EXTEND TO THE ORIGINAL CONSUMER PURCHASER OR ANY PERSON RECEIVING THIS TELEVISION AS A GIFT FROM THE ORIGINAL CONSUMER PURCHASER AND TO NO OTHER PURCHASER OR TRANSFEREE.

PRODUCTS PURCHASED IN THE U.S.A. AND USED IN CANADA ARE NOT COVERED BY THESE WARRANTIES.

PRODUCTS PURCHASED IN CANADA AND USED IN THE U.S.A. ARE NOT COVERED BY THESE WARRANTIES.

### Limited One (1) Year Warranty on Parts and Labor\*

TCL warrants this television and its parts against defects in materials or workmanship for a period of one (1) year after the date of original retail purchase. DURING THIS PERIOD, TCL WILL, AT TCL'S OPTION, REPAIR OR REPLACE A DEFECTIVE PART WITH A NEW OR REFURBISHED PART WITHOUT CHARGE TO YOU FOR PARTS OR LABOR. TCL Authorized Service Depot personnel will come to your home when warranty service is required. Depending on the type of repair required, either the service will be performed in your home or the set will be taken to the TCL Authorized Service Depot for repair and returned to your home at no cost to you. IN-HOME SERVICE ONLY APPLIES WITHIN 100 KILOMETERS OF AN AUTHORIZED TCL SERVICE DEPOT.

### Limited Two (2) Year Warranty on Picture Tube\*

TCL warrants the picture tube in this television against defects in materials or workmanship for a period of two (2) years after the date of original retail purchase. DURING THIS PERIOD, TCL WILL, AT TCL'S OPTION, REPAIR OR REPLACE A DEFECTIVE PICTURE TUBE WITH A NEW OR REFURBISHED PICTURE TUBE WITHOUT CHARGE TO YOU, EXCEPT THAT, IF A DEFECTIVE PICTURE TUBE IS REPAIRED OR REPLACED AFTER ONE (1) YEAR AFTER THE DATE OF THE ORIGINAL RETAIL PURCHASE, YOU MUST PAY ALL LABOR CHARGES INVOLVED IN THE REPAIR OR REPLACEMENT OF SUCH PICTURE TUBE. TCL Authorized Service Depot personnel will come to your home when warranty service is required. Depending on the type of repair required, either the service will be performed in your home or the set will be taken to the TCL Authorized Service Depot for repair and returned to your home at no cost to you. IN-HOME SERVICE ONLY APPLIES WITHIN 100 KILOMETERS OF AN AUTHORIZED TCL SERVICE DEPOT.

### Rental Units

The warranty for rental units begins with the date of first rental or thirty (30) days from the date of shipment to the rental firm, whichever comes first.

### \*Limited Warranty for Commercial Units

TCL warrants televisions sold and used for commercial purposes as follows: all parts are warranted against defects in materials or workmanship for a period of ninety (90) days after the date of original purchase. DURING THIS PERIOD, TCL WILL, AT TCL'S OPTION, REPAIR OR REPLACE A DEFECTIVE PART WITH A NEW OR REFURBISHED PART WITHOUT CHARGE TO YOU. ON-SITE SERVICE ONLY APPLIES WITHIN 100 KILOMETERS OF AN AUTHORIZED TCL SERVICE DEPOT.

### Owner's Manual and Product Registration

Read this owner's manual thoroughly before operating this television.

Register your product on-line at [www.toshiba.ca](http://www.toshiba.ca) as soon as possible. By registering your product you will enable TCL to bring you new products specifically designed to meet your needs and help us to contact you in the unlikely event a safety notification is required under the Consumer Product Safety Act. Failure to register your product does not diminish your warranty rights.

### Your Responsibility

THE ABOVE WARRANTIES ARE SUBJECT TO THE FOLLOWING CONDITIONS:

- (1) You must provide your bill of sale or other proof of purchase.
- (2) All warranty servicing of this television must be performed by an Authorized TCL Service Depot.
- (3) These warranties from TCL are effective only if the television is purchased in Canada from an authorized TCL dealer and operated in Canada.
- (4) Labor charges for installation, setup, adjustment of customer controls, and installation or repair of antenna systems are not covered by these warranties. Reception problems caused by inadequate antenna systems are your responsibility.
- (5) Warranties extend only to defects in materials or workmanship as limited above, and do not extend to any television or parts that have been lost or discarded by you or to damage to the television or parts caused by fires, misuse, accident, Acts of God (such as lightning or fluctuations in electric power), improper installation, improper maintenance, or use in violation of instructions furnished by TCL; use or malfunction through simultaneous use of this product and connected equipment; or to units that have been modified or had the serial number removed, altered, defaced, or rendered illegible.

### How to Obtain Warranty Services

If, after following all of the operating instructions in this manual and checking the "Troubleshooting" section, you find that service is needed:

- (1) To find the nearest TCL Authorized Service Depot, visit TCL's web site at [www.toshiba.ca](http://www.toshiba.ca).
- (2) Present your bill of sale or other proof of purchase to the Authorized Service Depot.

**For additional information,  
visit TCL's web site: [www.toshiba.ca](http://www.toshiba.ca)**

ALL WARRANTIES IMPLIED BY THE LAW OF ANY PROVINCE OF CANADA, INCLUDING THE IMPLIED WARRANTIES OF MERCHANTABILITY AND FITNESS FOR A PARTICULAR PURPOSE, ARE EXPRESSLY LIMITED TO THE DURATION OF THE LIMITED WARRANTIES SET FORTH ABOVE. WITH THE EXCEPTION OF ANY WARRANTIES IMPLIED BY THE LAW OF ANY PROVINCE OF CANADA AS HEREBY LIMITED, THE FOREGOING WARRANTY IS EXCLUSIVE AND IN LIEU OF ALL OTHER WARRANTIES, GUARANTEES, AGREEMENTS, AND SIMILAR OBLIGATIONS OF TCL WITH RESPECT TO THE REPAIR OR REPLACEMENT OF ANY PARTS. IN NO EVENT SHALL TCL BE LIABLE FOR CONSEQUENTIAL OR INCIDENTAL DAMAGES (INCLUDING, BUT NOT LIMITED TO, LOST PROFITS, BUSINESS INTERRUPTION, OR MODIFICATION OR ERASURE OF RECORDED DATA CAUSED BY USE, MISUSE, OR INABILITY TO USE THIS PRODUCT).

No person, agent, distributor, dealer, or company is authorized to change, modify, or extend the terms of these warranties in any manner whatsoever. The time within which action must be commenced to enforce any obligation of TCL arising under this warranty or under any law of Canada or of any province thereof is hereby limited to 90 days from the date you discover, or should have discovered, the defect. This limitation does not apply to implied warranties arising under the law of any province of Canada.

THIS WARRANTY GIVES YOU SPECIFIC LEGAL RIGHTS, AND YOU MAY ALSO HAVE OTHER RIGHTS, WHICH MAY VARY FROM PROVINCE TO PROVINCE IN CANADA. SOME PROVINCES OF CANADA DO NOT ALLOW LIMITATIONS ON THE DURATION OF AN IMPLIED WARRANTY, LIMITATIONS ON THE TIME WITHIN WHICH AN ACTION MAY BE BROUGHT, OR THE EXCLUSION OR LIMITATION OF INCIDENTAL OR CONSEQUENTIAL DAMAGES; THEREFORE, THE ABOVE LIMITATIONS OR EXCLUSIONS MAY NOT APPLY TO YOU UNDER SUCH CIRCUMSTANCES.

071304



# Notes





# Index

## A

A/V receiver connection .....	20
ANT 1/2 .....	10, 40, 67
Antenna cables .....	11
Audio system connection .....	20
Auto aspect .....	72
Auto convergence .....	49
Auto power off .....	87
A/V HD .....	23, 50

## B

Back of the TV .....	10
Blocking channels .....	90
Buttons, front panel .....	9

## C

Cable box connection .....	14, 16
CableCARD™ .....	12
CableClear™ DNR .....	78
Cables .....	11
Camcorder connection .....	13
CH ▲▼ buttons .....	69
Channel lock .....	90
CH RTN button .....	69
Channel Number buttons .....	69
Channel programming:	
Automatic programming .....	41
Manually adding and deleting .....	42
Cinema mode .....	73
Clock, setting .....	51
Closed captions .....	80
Color temperature .....	79
ColorStream® .....	7, 15, 17
Connecting devices .....	12-25
CompactFlash® memory cards .....	84
Component video cables .....	11
Component video (ColorStream®) .....	7, 15, 17
Convergence adjustment .....	49
CrystalScan HDSC .....	7

## D

Device connections .....	12-25
Defaults, restore TV factory .....	52
Digital Audio Out .....	20
Digital signal meter .....	52
Display format .....	73
DNR (Digital Noise Reduction) .....	78
Dolby Virtual with SRS TruSurround .....	83
Double-window POP feature .....	74
DTV receiver connection .....	15

DVD player connection .....	16, 17
DVHS A/VC .....	22, 50
DVI connection .....	19

## E F G H I

EIA-775 .....	22
FAV SCAN button .....	76
Factory defaults, restore TV .....	52
Favorite channels .....	43, 76
Features, TV .....	7
Flashing front panel lights .....	8, 9, 94
Focus, SRS WOW .....	83
Front of the TV .....	9
Front panel lock .....	91
Front panel lights .....	8, 9, 94
GameTimer™ .....	91
G-LINK connection .....	25
HD, A/V .....	23, 50
HDMI connection .....	19
IEEE-1394 .....	22
INPUT button .....	67
Input lock .....	90
Installation, care, and service .....	3-5, 8
Installation, setup .....	8
Integrated digital tuning .....	7
IR blaster .....	21

## L M

Labeling video inputs .....	68
Language selection .....	40
Last mode memory feature .....	87
LED indications .....	8, 9, 94
Lights on front panel .....	8, 9, 94
Locking video inputs .....	90
LOCKS menu .....	88
Channels, blocking .....	90
Enable rating blocking .....	89
GameTimer .....	91
MPAA rating .....	89
New PIN code .....	88
TV rating .....	89
Unlocking programs temporarily .....	90
Video inputs, locking .....	90
Memory cards .....	84
Memory Stick™ memory cards .....	84
Menu system .....	34, 35
MMC memory cards .....	84
MPEG-2 digital video signals .....	22
MTS feature .....	81
MUTE button .....	81

# Index *(continued)*

## **O P**

ON/OFF timer .....	86
Optical audio cable .....	11
Picture adjustments:	
Color temperature .....	79
Picture mode .....	77
Picture quality .....	77
Picture-out-picture (POP):	
FAV SCAN button .....	76
FREEZE button .....	75
SPLIT button .....	74
Picture scroll .....	72
Picture size selection .....	70

## **R**

RECALL button .....	87
Remote control:	
Battery installation .....	27
Device code table .....	32
Effective range .....	9, 27
Functional key chart .....	28
Learning about the buttons .....	26
Operational feature reset .....	31
Programming .....	30
Searching and sampling the code .....	30
Volume lock feature .....	31
RESET button .....	9
Restore TV factory defaults .....	52

## **S**

Safety, care, installation, and service .....	2-5
SAP sound .....	81
Satellite receiver connection .....	15
Scrolling the TheaterWide® picture .....	72
SD (Secure Digital™) memory cards .....	84
Service .....	4

Setup, TV .....	5, 8, 12-25, 40
Setup, TV Guide On Screen system .....	36
Sleep timer .....	87
SmartMedia™ memory cards .....	84
Sound quality adjustments .....	81
Speakers ON/OFF .....	82
Specifications .....	98
SpeedSurf .....	69
SRS WOW .....	83
StableSound® .....	82
Stereo sound .....	81
S-video cables .....	11
Symbio™ A/V HD .....	23, 50
System restore .....	52
System status .....	52

## **T**

TheaterNet™ DEVICE and CONTROL buttons .....	45
TheaterNet connection .....	21
TheaterNet setup .....	44
TheaterWide® picture .....	71
TouchFocus® automatic color convergence .....	49
Troubleshooting .....	92-94
TruBass, SRS WOW .....	83
TV Guide On Screen® .....	25, 36, 53

## **V**

V-Chip blocking (Locks menu) .....	88-90
VCR connection .....	13-18
VSM .....	79
Video cables .....	11
Video input labels .....	68
Video input lock .....	90

## **W**

Warranty .....	99, 100
WOW, SRS .....	83



## **TOSHIBA AMERICA CONSUMER PRODUCTS, L.L.C.**

HEAD OFFICE: 82 TOTOWA ROAD, WAYNE, NJ 07470, U.S.A.  
NATIONAL SERVICE DIVISION: 1420-B TOSHIBA DRIVE, LEBANON, TN 37087, U.S.A.

## **TOSHIBA OF CANADA LTD.**

HEAD OFFICE: 191 McNABB STREET, MARKHAM, ONTARIO, L3R 8H2, CANADA – TEL: (905) 470-5400

### SERVICE CENTERS:

TORONTO: 191 McNABB STREET, MARKHAM, ONTARIO L3R 8H2, CANADA – TEL: (905) 470-5400  
MONTREAL: 18050 TRANS CANADA, KIRKLAND, QUEBEC, H9J 4A1, CANADA – TEL: (514) 390-7766  
VANCOUVER: 22171 FRASERWOOD WAY, RICHMOND, B.C., V6W 1J5, CANADA – TEL: (604) 303-2500

MANUFACTURED BY

**TOSHIBA AMERICA CONSUMER PRODUCTS, L.L.C.**

ColorStream, FST PURE, StableSound, TouchFocus, and TheaterWide are registered trademarks of Toshiba America Consumer Products, L.L.C.  
CableClear, GameTimer, SurfLock, Symbio, and TheaterNet are trademarks of Toshiba America Consumer Products, L.L.C.  
SD (Secure Digital) memory card is a trademark of Matsushita Electric Industry, Toshiba Corporation, and SanDisk Corporation.  
SmartMedia is a registered trademark of Toshiba Corporation.

PRINTED IN USA  
(04-08)

Copyright © 2004 TOSHIBA CORPORATION. All rights reserved.

# **TOSHIBA**

23566378